







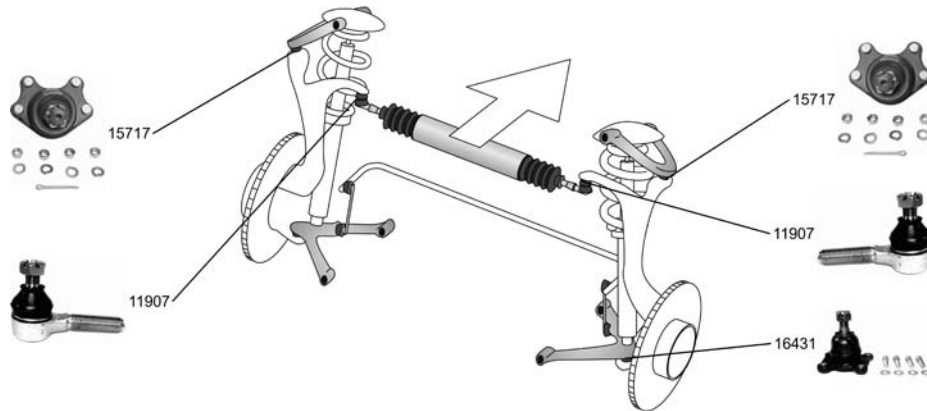

OE

TOYOTA

4 RUNNER (_N130)

08.87 - 03.96



<p>Spurstangenkopf / Tie-rod End Gewindeart: mit Linksgewinde / Thread Type: With left-hand thread Gewindemaß / Thread Size:M17x1,5 Aussengewinde [mm] / Outer Thread [mm]:M17x1,5 ALL TYPES ausser/except for : 2.4 TD (LN130) 08.89 - 11.95</p>		<p>11907 45046-39235</p> 
<p>Trag-/Führungsgelenk / Support-/ Steering Link Konusmaß [mm] / Cone Size [mm]:17,1 ALL TYPES ausser/except for : 2.4 TD (LN130) 08.89 - 11.95</p>		<p>15717 43360-39085</p> 
<p>Trag-/Führungsgelenk / Support-/ Steering Link 2.7 i 11.95 - 3.0 V6 (VZN 130) 07.90 - 11.95 3.4 i 11.95 - 3.0 Turbo-D (KZN 130) 10.93 - 03.96</p>		<p>16431 43330-39265</p> 

AVENSIS (_T22_)

09.97 -

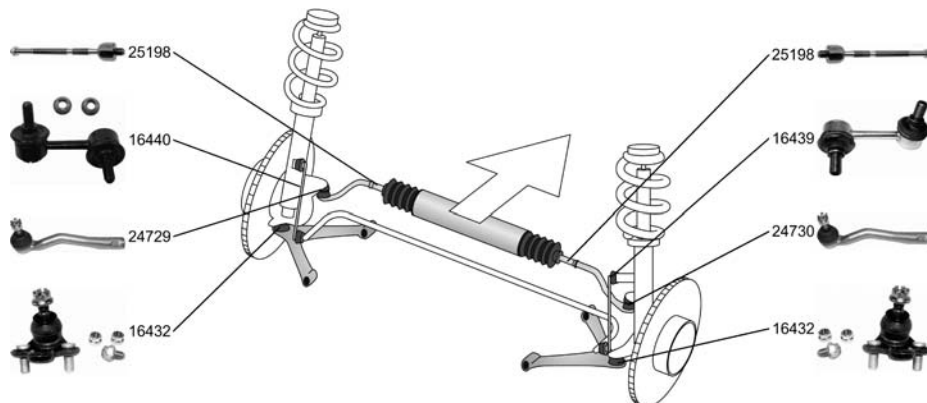











<p>Spurstangenkopf / Tie-rod End Gewindeart: mit Rechtsgewinde / Thread Type: with right-hand thread Innengewinde [mm] / Inner Thread [mm]:M14x1,5 ALL TYPES ausser/except for : 1.6 VVT-i 10.00 - 1.8 VVT-i 10.00 - 2.0 VVT-i 10.00 -</p>		<p>24729 45047-29125</p> 
<p>Spurstangenkopf / Tie-rod End Gewindeart: mit Rechtsgewinde / Thread Type: with right-hand thread Innengewinde [mm] / Inner Thread [mm]:M14x1,5 Gewindemaß / Thread Size:M14x1,5 ALL TYPES ausser/except for : 1.6 VVT-i 10.00 - 1.8 VVT-i 10.00 - 2.0 VVT-i 10.00 -</p>		<p>24730 45046-29365</p> 



TOYOTA

AVENSIS (_T22_)





09.97 -

<p> Axialgelenk, Spurstange / Axial Rod, tie rod</p> <p>ALL TYPES ausser/except for :</p> <table border="1"> <tr><td>1.6 VVT-i</td><td>10.00 -</td></tr> <tr><td>1.8 VVT-i</td><td>10.00 -</td></tr> <tr><td>2.0 VVT-i</td><td>10.00 -</td></tr> </table>	1.6 VVT-i	10.00 -	1.8 VVT-i	10.00 -	2.0 VVT-i	10.00 -		<p>25198 45503-05020</p> 
1.6 VVT-i	10.00 -							
1.8 VVT-i	10.00 -							
2.0 VVT-i	10.00 -							
<p>Trag-/Führungsgelenk / Support-/ Steering Link</p> <p>2.0 (ST220_) 09.97 - 10.00</p>	<p>▼</p> <p>Aggregate/Rollen: angetr. Agg.: Generator / Units / Pulleys: Driven unit: alternator</p>	<p>15715 43330-29326</p> 						
<p>Trag-/Führungsgelenk / Support-/ Steering Link</p> <p>Konusmaß [mm] / Cone Size [mm]:15</p> <p>ALL TYPES</p>		<p>16432 43330-29375</p> 						
<p>Stange/Strebe, Stabilisator / Rod/Strut, stabiliser</p> <p>Pendelstange / Suspension Rod</p> <p>ALL TYPES ausser/except for :</p> <table border="1"> <tr><td>1.6 VVT-i</td><td>10.00 -</td></tr> <tr><td>1.8 VVT-i</td><td>10.00 -</td></tr> <tr><td>2.0 VVT-i</td><td>10.00 -</td></tr> </table>	1.6 VVT-i	10.00 -	1.8 VVT-i	10.00 -	2.0 VVT-i	10.00 -	<p>▼ </p>	<p>16439 48820-05012</p> 
1.6 VVT-i	10.00 -							
1.8 VVT-i	10.00 -							
2.0 VVT-i	10.00 -							
<p>Stange/Strebe, Stabilisator / Rod/Strut, stabiliser</p> <p>Pendelstange / Suspension Rod</p> <p>ALL TYPES ausser/except for :</p> <table border="1"> <tr><td>1.6 VVT-i</td><td>10.00 -</td></tr> <tr><td>1.8 VVT-i</td><td>10.00 -</td></tr> <tr><td>2.0 VVT-i</td><td>10.00 -</td></tr> </table>	1.6 VVT-i	10.00 -	1.8 VVT-i	10.00 -	2.0 VVT-i	10.00 -	<p></p>	<p>16440 48810-05012</p> 
1.6 VVT-i	10.00 -							
1.8 VVT-i	10.00 -							
2.0 VVT-i	10.00 -							

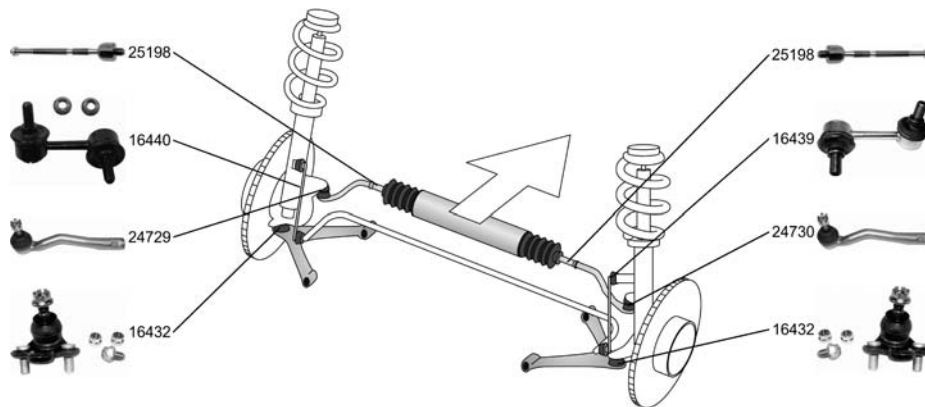
AVENSIS Liftback/Hatchback/avec hayon (_T22_)

09.97 -



<p>Spurstangenkopf / Tie-rod End</p> <p>Gewindeart: mit Rechtsgewinde / Thread Type: with right-hand thread Innengewinde [mm] / Inner Thread [mm]:M14x1,5</p> <p>ALL TYPES ausser/except for :</p> <table border="1"> <tr><td>1.6 VVT-i</td><td>10.00 -</td></tr> <tr><td>1.8 VVT-i</td><td>10.00 -</td></tr> <tr><td>2.0 VVT-i</td><td>10.00 -</td></tr> </table>	1.6 VVT-i	10.00 -	1.8 VVT-i	10.00 -	2.0 VVT-i	10.00 -		<p>24729 45047-29125</p> 
1.6 VVT-i	10.00 -							
1.8 VVT-i	10.00 -							
2.0 VVT-i	10.00 -							
<p>Spurstangenkopf / Tie-rod End</p> <p>Gewindeart: mit Rechtsgewinde / Thread Type: with right-hand thread Innengewinde [mm] / Inner Thread [mm]:M14x1,5 Gewindemaß / Thread Size:M14x1,5</p> <p>ALL TYPES ausser/except for :</p> <table border="1"> <tr><td>1.6 VVT-i</td><td>10.00 -</td></tr> <tr><td>1.8 VVT-i</td><td>10.00 -</td></tr> <tr><td>2.0 VVT-i</td><td>10.00 -</td></tr> </table>	1.6 VVT-i	10.00 -	1.8 VVT-i	10.00 -	2.0 VVT-i	10.00 -		<p>24730 45046-29365</p> 
1.6 VVT-i	10.00 -							
1.8 VVT-i	10.00 -							
2.0 VVT-i	10.00 -							



OE





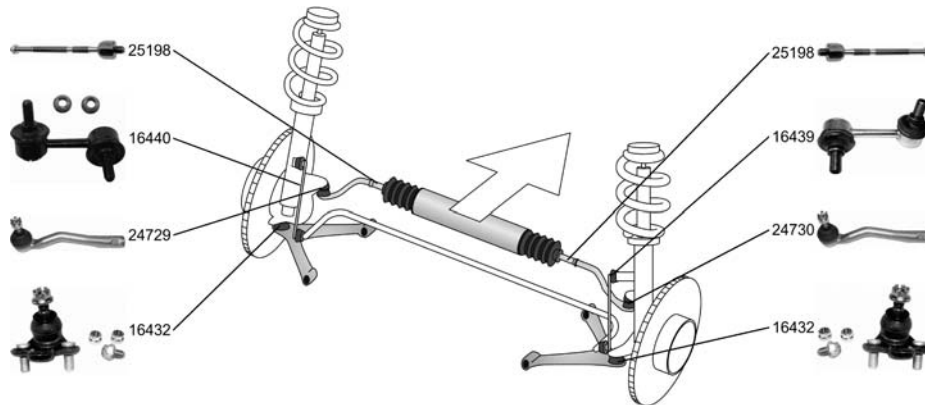

TOYOTA

AVENSIS Liftback/Hatchback/avec hayon (_T22_) 09.97 -

<p> Axialgelenk, Spurstange / Axial Rod, tie rod</p> <p>ALL TYPES ausser/except for :</p> <table border="1"> <tr><td>1.6 VVT-i</td><td>10.00 -</td></tr> <tr><td>1.8 VVT-i</td><td>10.00 -</td></tr> <tr><td>2.0 VVT-i</td><td>10.00 -</td></tr> </table>	1.6 VVT-i	10.00 -	1.8 VVT-i	10.00 -	2.0 VVT-i	10.00 -		<p>25198 45503-05020</p> 
1.6 VVT-i	10.00 -							
1.8 VVT-i	10.00 -							
2.0 VVT-i	10.00 -							
<p>Trag-/Führungsgelenk / Support-/ Steering Link Konusmaß [mm] / Cone Size [mm]:15</p> <p>ALL TYPES</p>		<p>16432 43330-29375</p> 						
<p>Stange/Strebe, Stabilisator / Rod/Strut, stabiliser Pendelstange / Suspension Rod</p> <p>ALL TYPES ausser/except for :</p> <table border="1"> <tr><td>1.6 VVT-i</td><td>10.00 -</td></tr> <tr><td>1.8 VVT-i</td><td>10.00 -</td></tr> <tr><td>2.0 VVT-i</td><td>10.00 -</td></tr> </table>	1.6 VVT-i	10.00 -	1.8 VVT-i	10.00 -	2.0 VVT-i	10.00 -		<p>16439 48820-05012</p> 
1.6 VVT-i	10.00 -							
1.8 VVT-i	10.00 -							
2.0 VVT-i	10.00 -							
<p>Stange/Strebe, Stabilisator / Rod/Strut, stabiliser Pendelstange / Suspension Rod</p> <p>ALL TYPES ausser/except for :</p> <table border="1"> <tr><td>1.6 VVT-i</td><td>10.00 -</td></tr> <tr><td>1.8 VVT-i</td><td>10.00 -</td></tr> <tr><td>2.0 VVT-i</td><td>10.00 -</td></tr> </table>	1.6 VVT-i	10.00 -	1.8 VVT-i	10.00 -	2.0 VVT-i	10.00 -		<p>16440 48810-05012</p> 
1.6 VVT-i	10.00 -							
1.8 VVT-i	10.00 -							
2.0 VVT-i	10.00 -							

AVENSIS Station Wagon/Estate/Break (_T22_) 09.97 -











<p>Spurstangenkopf / Tie-rod End Gewindeart: mit Rechtsgewinde / Thread Type: with right-hand thread Innengewinde [mm] / Inner Thread [mm]:M14x1,5</p> <p>ALL TYPES ausser/except for :</p> <table border="1"> <tr><td>1.6 VVT-i</td><td>10.00 -</td></tr> <tr><td>1.8 VVT-i</td><td>10.00 -</td></tr> <tr><td>2.0 VVT-i</td><td>10.00 -</td></tr> </table>	1.6 VVT-i	10.00 -	1.8 VVT-i	10.00 -	2.0 VVT-i	10.00 -		<p>24729 45047-29125</p> 
1.6 VVT-i	10.00 -							
1.8 VVT-i	10.00 -							
2.0 VVT-i	10.00 -							
<p>Spurstangenkopf / Tie-rod End Gewindeart: mit Rechtsgewinde / Thread Type: with right-hand thread Innengewinde [mm] / Inner Thread [mm]:M14x1,5 Gewindemaß / Thread Size:M14x1,5</p> <p>ALL TYPES ausser/except for :</p> <table border="1"> <tr><td>1.6 VVT-i</td><td>10.00 -</td></tr> <tr><td>1.8 VVT-i</td><td>10.00 -</td></tr> <tr><td>2.0 VVT-i</td><td>10.00 -</td></tr> </table>	1.6 VVT-i	10.00 -	1.8 VVT-i	10.00 -	2.0 VVT-i	10.00 -		<p>24730 45046-29365</p> 
1.6 VVT-i	10.00 -							
1.8 VVT-i	10.00 -							
2.0 VVT-i	10.00 -							
<p>Axialgelenk, Spurstange / Axial Rod, tie rod</p> <p>ALL TYPES ausser/except for :</p> <table border="1"> <tr><td>1.6 VVT-i</td><td>10.00 -</td></tr> <tr><td>1.8 VVT-i</td><td>10.00 -</td></tr> <tr><td>2.0 VVT-i</td><td>10.00 -</td></tr> </table>	1.6 VVT-i	10.00 -	1.8 VVT-i	10.00 -	2.0 VVT-i	10.00 -		<p>25198 45503-05020</p> 
1.6 VVT-i	10.00 -							
1.8 VVT-i	10.00 -							
2.0 VVT-i	10.00 -							





TOYOTA

AVENSIS Station Wagon/Estate/Break (_T22_) 09.97 -

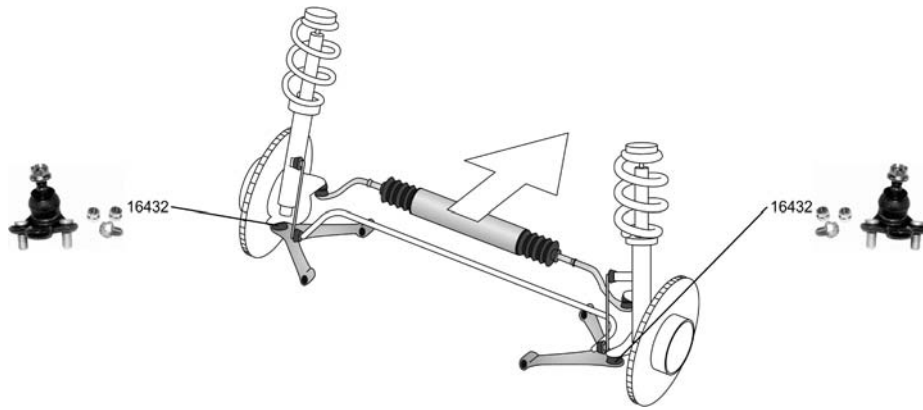

 Trag-/Führungsgelenk / Support-/ Steering Link 2.0 (ST220_) 09.97 - 10.00	 Aggregate/Rollen: anetr. Agg.: Generator / Units / Pulleys: Driven unit: alternator	15715 43330-29326 
Trag-/Führungsgelenk / Support-/ Steering Link Konusmaß [mm] / Cone Size [mm]:15 ALL TYPES		16432 43330-29375 
Stange/Strebe, Stabilisator / Rod/Strut, stabiliser Pendelstange / Suspension Rod ALL TYPES ausser/except for : 1.6 VVT-i 10.00 - 1.8 VVT-i 10.00 - 2.0 VVT-i 10.00 -		16439 48820-05012 
Stange/Strebe, Stabilisator / Rod/Strut, stabiliser Pendelstange / Suspension Rod ALL TYPES ausser/except for : 1.6 VVT-i 10.00 - 1.8 VVT-i 10.00 - 2.0 VVT-i 10.00 -		16440 48810-05012 

AVENSIS VERSO 08.01 -





Trag-/Führungsgelenk / Support-/ Steering Link Konusmaß [mm] / Cone Size [mm]:15 ALL TYPES		16432 43330-29375 
---	---	---

AVENSIS (T25) 04.03 -

 Stange/Strebe, Stabilisator / Rod/Strut, stabiliser Pendelstange / Suspension Rod 1.8 04.03 - 2.0 04.03 - 2.4, 120 kW 10.03 -		29797 48820-47010 
--	---	---

AVENSIS Combi/Estate/Break (T25) 03.04 -



 Stange/Strebe, Stabilisator / Rod/Strut, stabiliser Pendelstange / Suspension Rod 1.8 04.03 - 2.0 04.03 - 2.4, 120 kW 10.03 -		29797 48820-47010 
--	---	---







OE

TOYOTA

AVENSIS Stufenheck/Saloon/avec coffre (T25) 03.04 -





	Stange/Strebe, Stabilisator / Rod/Strut, stabiliser Pendelstange / Suspension Rod		29797	48820-47010
	1.8	04.03 -		
	2.0	04.03 -		
	2.4, 120 kW	10.03 -		

CAMRY Liftback/Hatchback/avec hayon (V1) 02.83 - 01.88

	Axialgelenk, Spurstange / Axial Rod, tie rod Gewindart: mit Rechtsgewinde / Thread Type: with right-hand thread Gewindemaß / Thread Size: M14x1,5		15737	45503-39015
	2.0	04.86 - 01.88		
	1.8 Turbo-D	10.84 - 01.88		
	Trag-/Führungsgelenk / Support-/ Steering Link		11900	43330-39275
	1.8	02.83 - 10.86		
	2.0	04.86 - 01.88		
	1.8 Turbo-D	10.84 - 01.88		





CAMRY Stufenheck/Saloon/avec coffre (V1) 02.83 - 01.88

	Axialgelenk, Spurstange / Axial Rod, tie rod Gewindart: mit Rechtsgewinde / Thread Type: with right-hand thread Gewindemaß / Thread Size: M14x1,5		15737	45503-39015
	ALL TYPES			
	Trag-/Führungsgelenk / Support-/ Steering Link		11900	43330-39275
	ALL TYPES			

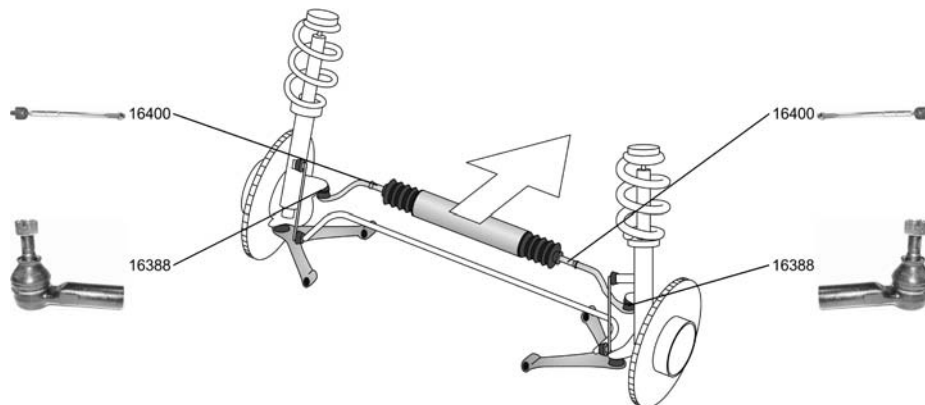

CAMRY (_V1_) 06.91 - 08.96



	Spurstangenkopf / Tie-rod End ALL TYPES		16388	45046-29255









OE

TOYOTA

CAMRY (_V1_)





06.91 - 08.96

	Axialgelenk, Spurstange / Axial Rod, tie rod ALL TYPES		16400	45503-39135
				
	Lagerung, Lenker / Mounting, wishbone ALL TYPES	08.1994->	26601	48655-33040
				

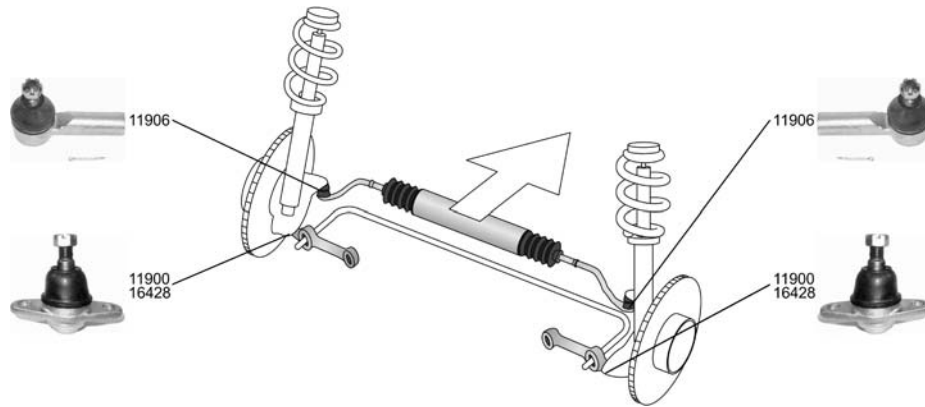
CAMRY (_V2_)

10.86 - 05.91



Spurstangenkopf / Tie-rod End Gewindeart: mit Rechtsgewinde / Thread Type: with right-hand thread Gewindemaß / Thread Size:M14x1,5 Innengewinde [mm] / Inner Thread [mm]:M14x1,5		11906	45046-29305	
ALL TYPES ausser/except for : 2.0 i 16V 4WD (SV25) 08.88 - 12.92				
Trag-/Führungsgelenk / Support-/ Steering Link ALL TYPES ausser/except for : 2.0 i 16V 4WD (SV25) 08.88 - 12.92		11900	43330-39275	
				
Trag-/Führungsgelenk / Support-/ Steering Link Konusmaß [mm] / Cone Size [mm]:18,2 ALL TYPES ausser/except for : 2.0 i 16V 4WD (SV25) 08.88 - 12.92		16428		
				
	Stange/Strebe, Stabilisator / Rod/Strut, stabiliser Pendelstange / Suspension Rod ohne Zubehör / without accessories		14945	48830-20010
ALL TYPES ausser/except for : 2.0 i 16V 4WD (SV25) 08.88 - 12.92				









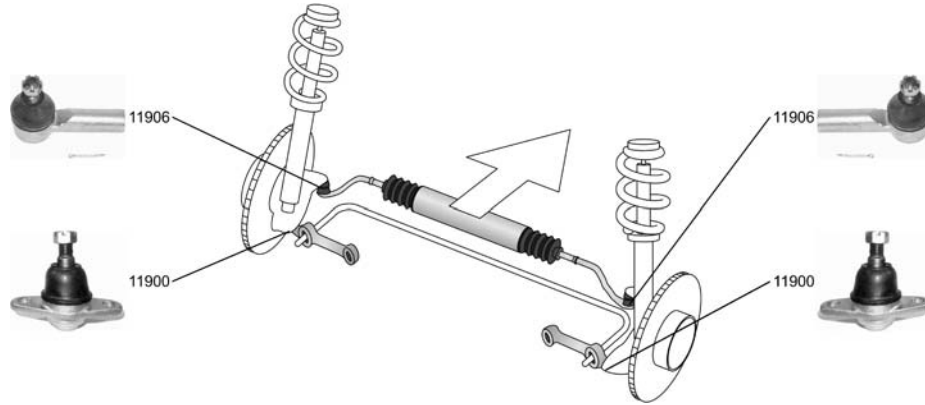

OE

TOYOTA

**CAMRY Station
Wagon/Estate/Break (_V2_)**

11.86 - 05.91





<p>Spurstangenkopf / Tie-rod End Gewindeart: mit Rechtsgewinde / Thread Type: with right-hand thread Gewindemaß / Thread Size: M14x1,5 Innengewinde [mm] / Inner Thread [mm]: M14x1,5 ALL TYPES</p>		<p>11906 45046-29305</p> 
<p>Trag-/Führungsgelenk / Support-/ Steering Link ALL TYPES ausser/except for : 1.8 (SV20_) 11.86 - 08.88</p>		<p>11900 43330-39275</p> 
<p> Stange/Strebe, Stabilisator / Rod/Strut, stabiliser Pendelstange / Suspension Rod ohne Zubehör / without accessories ALL TYPES</p>		<p>14945 48830-20010</p> 

**CAMRY Station
Wagon/Estate/Break (_V10)**

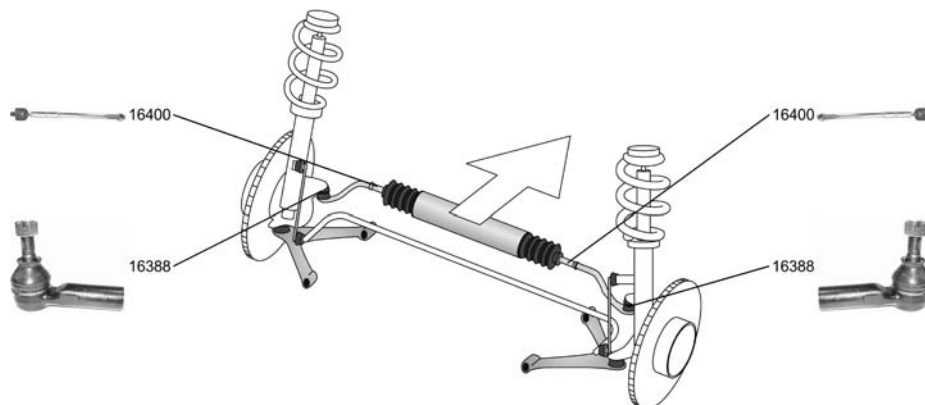
06.91 - 06.97







<p>Spurstangenkopf / Tie-rod End ALL TYPES</p>		<p>16388 45046-29255</p> 
--	---	--







TOYOTA

CAMRY Station Wagon/Estate/Break (_V10) 06.91 - 06.97

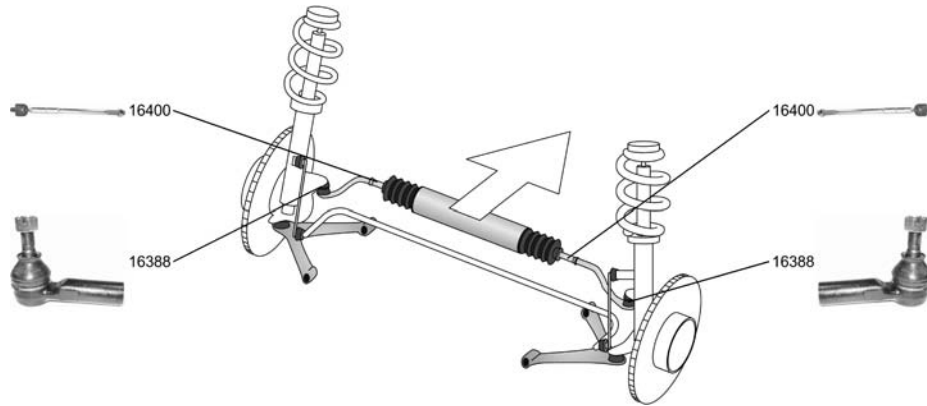



 Axialgelenk, Spurstange / Axial Rod, tie rod ALL TYPES		16400 45503-39135 
Lagerung, Lenker / Mounting, wishbone ALL TYPES		26601 48655-33040 

CAMRY (_V20) 08.96 - 11.01



Spurstangenkopf / Tie-rod End 2.2 (SXV20_) 08.96 - 11.01 2.2 11.00 - 11.01		16388 45046-29255 
Axialgelenk, Spurstange / Axial Rod, tie rod 2.2 (SXV20_) 08.96 - 11.01		16400 45503-39135 

CARINA II (_T15_) 10.83 - 05.88

 Spurstangenkopf / Tie-rod End Gewindeart: mit Rechtsgewinde / Thread Type: with right-hand thread Gewindemaß / Thread Size: M14x1,5 Innengewinde [mm] / Inner Thread [mm]: M14x1,5 1.6 (AT151) 10.83 - 11.87 2.0 D 02.84 - 05.88 2.0 D (CT150) 12.85 - 11.87 1.8 GLI (ST150) 10.83 - 11.87		11906 45046-29305 
Spurstangenkopf / Tie-rod End Gewindeart: mit Rechtsgewinde / Thread Type: with right-hand thread Gewindemaß / Thread Size: M12x1,25 1.6 (AT151), 55 kW 10.83 - 11.87 1.6 (AT151), 62 kW 10.83 - 11.87 1.8 GLI (ST150) 10.83 - 11.87 2.0 D 02.84 - 05.88		15725 45046-29135 





















OE

TOYOTA













CARINA II (_T15_)

10.83 - 05.88

 Axialgelenk, Spurstange / Axial Rod, tie rod Gewindeart: mit Rechtsgewinde / Thread Type: with right-hand thread Gewindemaß / Thread Size:M14x1,5			11914 45503-19036 	
	1.6 (AT151)	10.83 - 11.87		
	2.0 D	02.84 - 05.88		
	2.0 D (CT150)	12.85 - 11.87		
1.8 GLI (ST150)	10.83 - 11.87	 09.1984->		
Axialgelenk, Spurstange / Axial Rod, tie rod Gewindeart: mit Rechtsgewinde / Thread Type: with right-hand thread Gewindemaß / Thread Size:M14x1,5			15734 45503-19035 	
	1.6 (AT151), 55 kW	10.83 - 11.87		
	1.6 (AT151), 62 kW	10.83 - 11.87		
	1.8 GLI (ST150)	10.83 - 11.87		
2.0 D	02.84 - 05.88	->08.1984		
Axialgelenk, Spurstange / Axial Rod, tie rod Gewindeart: mit Rechtsgewinde / Thread Type: with right-hand thread Gewindemaß / Thread Size:M14x1,5			16390 45503-19056 	
	1.6 (AT151)	10.83 - 11.87		
	2.0 D	02.84 - 05.88		
	2.0 D (CT150)	12.85 - 11.87		
1.8 GLI (ST150)	10.83 - 11.87	 09.1984->		
Trag-/Führungsgelenk / Support-/ Steering Link Konusmaß [mm] / Cone Size [mm]:15,9			11897 43330-29205 	
	1.6 (AT151), 55 kW	10.83 - 11.87		
	1.6 (AT151), 62 kW	10.83 - 11.87		
	2.0 D	02.84 - 05.88		
2.0 D (CT150)	12.85 - 11.87			
1.6 (AT151), 63 kW	10.86 - 11.87			
1.8 GLI (ST150)	10.83 - 11.87			
Trag-/Führungsgelenk / Support-/ Steering Link Konusmaß [mm] / Cone Size [mm]:15,9			16429 43330-29185 	
	1.6 (AT151), 55 kW	10.83 - 11.87		
	1.6 (AT151), 62 kW	10.83 - 11.87		
	2.0 D	02.84 - 05.88		
2.0 D (CT150)	12.85 - 11.87			

CARINA II Stufenheck/Saloon/avec coffre (_T15_)

10.83 - 05.88















 Spurstangenkopf / Tie-rod End Gewindeart: mit Rechtsgewinde / Thread Type: with right-hand thread Gewindemaß / Thread Size:M14x1,5 Innengewinde [mm] / Inner Thread [mm]:M14x1,5			11906 45046-29305 	
	1.6 (AT151)	10.83 - 11.87		
	2.0 D	02.84 - 05.88		
1.8 GLI (ST150)	10.83 - 11.87	09.1984->		
Spurstangenkopf / Tie-rod End Gewindeart: mit Rechtsgewinde / Thread Type: with right-hand thread Gewindemaß / Thread Size:M12x1,25			15725 45046-29135 	
	ALL TYPES			->08.1984
Axialgelenk, Spurstange / Axial Rod, tie rod Gewindeart: mit Rechtsgewinde / Thread Type: with right-hand thread Gewindemaß / Thread Size:M14x1,5			11914 45503-19036 	
	1.6 (AT151)	10.83 - 11.87		
	2.0 D	02.84 - 05.88		
	1.8 GLI (ST150)	10.83 - 11.87		
		 09.1984->		
Axialgelenk, Spurstange / Axial Rod, tie rod Gewindeart: mit Rechtsgewinde / Thread Type: with right-hand thread Gewindemaß / Thread Size:M14x1,5			15734 45503-19035 	
	ALL TYPES			 ->08.1984



TOYOTA

CARINA II Stufenheck/Saloon/avec coffre (_T15_)





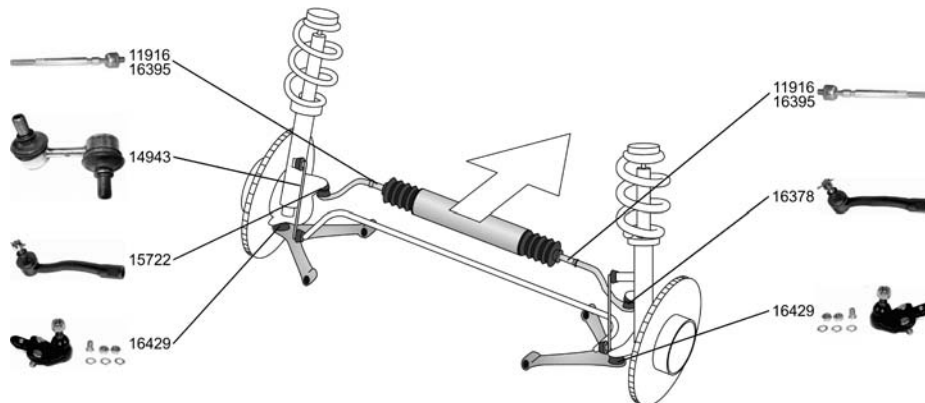

10.83 - 05.88

 Axialgelenk, Spurstange / Axial Rod, tie rod Gewindeart: mit Rechtsgewinde / Thread Type: with right-hand thread Gewindemaß / Thread Size: M14x1,5			16390 45503-19056 	
	1.6 (AT151)	10.83 - 11.87		
	2.0 D	02.84 - 05.88		
1.8 GLI (ST150)	10.83 - 11.87		09.1984->	
Trag-/Führungsgelenk / Support-/ Steering Link Konusmaß [mm] / Cone Size [mm]: 15,9			11897 43330-29205 	
	1.6 (AT151)	10.83 - 11.87		
	2.0 D	02.84 - 05.88		
1.8 GLI (ST150)	10.83 - 11.87			
Trag-/Führungsgelenk / Support-/ Steering Link Konusmaß [mm] / Cone Size [mm]: 15,9			16429 43330-29185 	
	1.6 (AT151)	10.83 - 11.87		
	2.0 D	02.84 - 05.88		

CARINA II (_T17_)

12.87 - 06.93



Spurstangenkopf / Tie-rod End Gewindeart: mit Rechtsgewinde / Thread Type: with right-hand thread Gewindemaß / Thread Size: M15x1,5 Achsausführung / Axle Version: SMI Innengewinde [mm] / Inner Thread [mm]: M15x1,5			15722 45047-29045 	
	ALL TYPES ausser/except for :			
	1.8 i (ST 171)	12.87 - 03.92		
1.8 D (CT 170)	12.87 - 03.92			
Spurstangenkopf / Tie-rod End Gewindeart: mit Rechtsgewinde / Thread Type: with right-hand thread Gewindemaß / Thread Size: M15x1,5 Achsausführung / Axle Version: SMI			16378 45046-29165 	
	ALL TYPES ausser/except for :			
	1.8 i (ST 171)	12.87 - 03.92		
1.8 D (CT 170)	12.87 - 03.92			
Axialgelenk, Spurstange / Axial Rod, tie rod Gewindemaß / Thread Size: M14x1,5 Gewindeart: mit Rechtsgewinde / Thread Type: with right-hand thread Achsausführung / Axle Version: SMI			11916 45503-29155 	
	ALL TYPES ausser/except for :			
	1.8 i (ST 171)	12.87 - 03.92		
1.8 D (CT 170)	12.87 - 03.92			













OE

TOYOTA

CARINA II (_T17_)

12.87 - 06.93





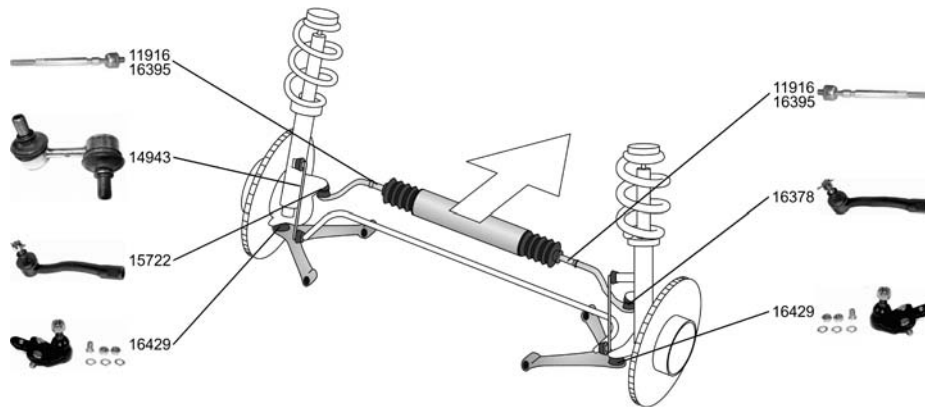

	Axialgelenk, Spurstange / Axial Rod, tie rod für / for:SMI Gewindemaß / Thread Size:M15x1,5 Gewindeart: mit Rechtsgewinde / Thread Type: with right-hand thread Achsausführung / Axle Version:SMI		16395 45503-29165	
ALL TYPES ausser/except for : 1.8 i (ST 171) 12.87 - 03.92 1.8 D (CT 170) 12.87 - 03.92				
	Trag-/Führungsgelenk / Support-/ Steering Link Konusmaß [mm] / Cone Size [mm]:15,9		16429 43330-29185	
ALL TYPES ausser/except for : 1.8 i (ST 171) 12.87 - 03.92 1.8 D (CT 170) 12.87 - 03.92				
	Stange/Strebe, Stabilisator / Rod/Strut, stabiliser Pendelstange / Suspension Rod		14943 48810-20010	
ALL TYPES ausser/except for : 1.8 i (ST 171) 12.87 - 03.92 1.8 D (CT 170) 12.87 - 03.92				
	Stange/Strebe, Stabilisator / Rod/Strut, stabiliser Pendelstange / Suspension Rod ohne Zubehör / without accessories		14945 48830-20010	
ALL TYPES ausser/except for : 1.8 i (ST 171) 12.87 - 03.92 1.8 D (CT 170) 12.87 - 03.92				

CARINA II Station

12.87 - 04.92

Wagon/Estate/Break (_T17_)











Spurstangenkopf / Tie-rod End Gewindeart: mit Rechtsgewinde / Thread Type: with right-hand thread Gewindemaß / Thread Size:M15x1,5 Achsausführung / Axle Version:SMI Innengewinde [mm] / Inner Thread [mm]:M15x1,5		15722 45047-29045	
ALL TYPES			
Spurstangenkopf / Tie-rod End Gewindeart: mit Rechtsgewinde / Thread Type: with right-hand thread Gewindemaß / Thread Size:M15x1,5 Achsausführung / Axle Version:SMI		16378 45046-29165	
ALL TYPES			
Axialgelenk, Spurstange / Axial Rod, tie rod Gewindemaß / Thread Size:M14x1,5 Gewindeart: mit Rechtsgewinde / Thread Type: with right-hand thread Achsausführung / Axle Version:SMI		11916 45503-29155	
ALL TYPES			



TOYOTA

CARINA II Station Wagon/Estate/Break (_T17_)





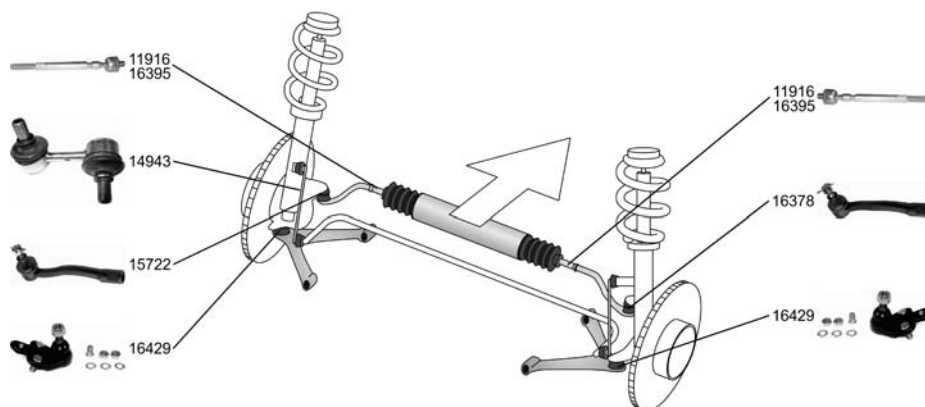

12.87 - 04.92

 Axialgelenk, Spurstange / Axial Rod, tie rod für / for:SMI Gewindemaß / Thread Size:M15x1,5 Gewindeart: mit Rechtsgewinde / Thread Type: with right-hand thread Achsausführung / Axle Version:SMI ALL TYPES		16395 45503-29165 
Trag-/Führungsgelenk / Support-/ Steering Link Konusmaß [mm] / Cone Size [mm]:15,9 ALL TYPES		16429 43330-29185 
Stange/Strebe, Stabilisator / Rod/Strut, stabiliser Pendelstange / Suspension Rod ALL TYPES		14943 48810-20010 
Stange/Strebe, Stabilisator / Rod/Strut, stabiliser Pendelstange / Suspension Rod ohne Zubehör / without accessories ALL TYPES		14945 48830-20010 

CARINA II Stufenheck/Saloon/avec coffre (_T17_)

12.87 - 06.93



Spurstangenkopf / Tie-rod End Gewindeart: mit Rechtsgewinde / Thread Type: with right-hand thread Gewindemaß / Thread Size:M15x1,5 Achsausführung / Axle Version:SMI Innengewinde [mm] / Inner Thread [mm]:M15x1,5 ALL TYPES		15722 45047-29045 
Spurstangenkopf / Tie-rod End Gewindeart: mit Rechtsgewinde / Thread Type: with right-hand thread Gewindemaß / Thread Size:M15x1,5 Achsausführung / Axle Version:SMI ALL TYPES		16378 45046-29165 
Axialgelenk, Spurstange / Axial Rod, tie rod Gewindemaß / Thread Size:M14x1,5 Gewindeart: mit Rechtsgewinde / Thread Type: with right-hand thread Achsausführung / Axle Version:SMI ALL TYPES		11916 45503-29165 











OE

TOYOTA

CARINA II Stufenheck/Saloon/avec coffre (_T17_)





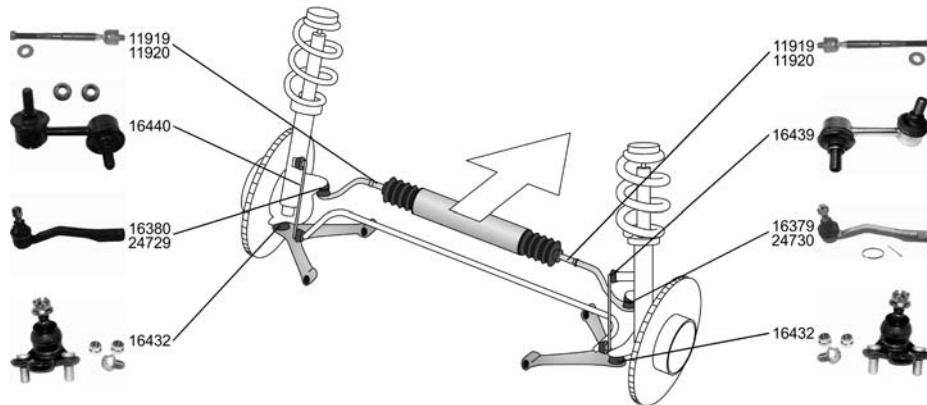

12.87 - 06.93

	Axialgelenk, Spurstange / Axial Rod, tie rod für / for:SMI Gewindemaß / Thread Size:M15x1,5 Gewindeart: mit Rechtsgewinde / Thread Type: with right-hand thread Achsausführung / Axle Version:SMI ALL TYPES		16395 45503-29165	
	Trag-/Führungsgelenk / Support-/ Steering Link Konusmaß [mm] / Cone Size [mm]:15,9 ALL TYPES		16429 43330-29185	
	Stange/Strebe, Stabilisator / Rod/Strut, stabiliser Pendelstange / Suspension Rod ALL TYPES		14943 48810-20010	
	Stange/Strebe, Stabilisator / Rod/Strut, stabiliser Pendelstange / Suspension Rod ohne Zubehör / without accessories ALL TYPES		14945 48830-20010	

CARINA E (_T19_)

04.92 - 09.97





















Spurstangenkopf / Tie-rod End Innengewinde [mm] / Inner Thread [mm]:M15x1,5 Gewindeart: mit Rechtsgewinde / Thread Type: with right-hand thread ALL TYPES		16379 45046-29335	
Spurstangenkopf / Tie-rod End Innengewinde [mm] / Inner Thread [mm]:M15x1,5 Gewindeart: mit Rechtsgewinde / Thread Type: with right-hand thread ALL TYPES		16380 45047-29075	
Spurstangenkopf / Tie-rod End Gewindeart: mit Rechtsgewinde / Thread Type: with right-hand thread Innengewinde [mm] / Inner Thread [mm]:M14x1,5 ALL TYPES		24729 45047-29125	



TOYOTA

CARINA E (_T19_)

04.92 - 09.97

 Spurstangenkopf / Tie-rod End Gewindeart: mit Rechtsgewinde / Thread Type: with right-hand thread Innengewinde [mm] / Inner Thread [mm]:M14x1,5 Gewindemaß / Thread Size:M14x1,5		24730 45046-29365 
ALL TYPES		
Axialgelenk, Spurstange / Axial Rod, tie rod für Lenkgetriebe-ID / For steering rack ID:ZF Länge über Alles [mm] / Overall Length [mm]:254 Aussengewinde [mm] / Outer Thread [mm]:M15x1,5		11919 45503-05010 
ALL TYPES		
Axialgelenk, Spurstange / Axial Rod, tie rod für Lenkgetriebe-ID / For steering rack ID:JP Länge über Alles [mm] / Overall Length [mm]:260 Aussengewinde [mm] / Outer Thread [mm]:M15x1,5		11920 45503-29475 
ALL TYPES		
Trag-/Führungsgelenk / Support-/ Steering Link Konusmaß [mm] / Cone Size [mm]:15		16432 43330-29375 
ALL TYPES		
Stange/Strebe, Stabilisator / Rod/Strut, stabiliser Pendelstange / Suspension Rod		16439 48820-05012 
ALL TYPES		
Stange/Strebe, Stabilisator / Rod/Strut, stabiliser Pendelstange / Suspension Rod		16440 48810-05012 
ALL TYPES		
Faltenbalgsatz, Lenkung / Bellow Kit, steering system		30227 45535-05010 
ALL TYPES		
Faltenbalgsatz, Lenkung / Bellow Kit, steering system		30230 45535-12100 
ALL TYPES		
Faltenbalgsatz, Lenkung / Bellow Kit, steering system		30240 45535-20080 für / for:Nastech
ALL TYPES		











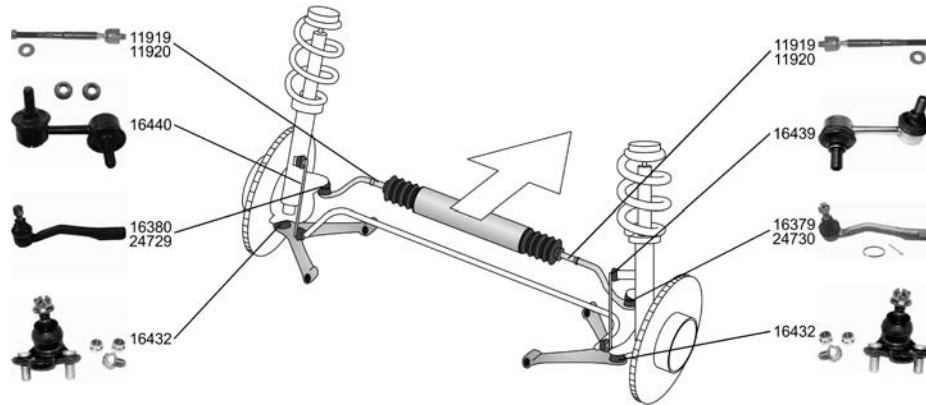







OE

TOYOTA

CARINA E
Sportswagon/Estate/Break (_T19_)

01.93 - 09.97











<p>Spurstangenkopf / Tie-rod End Innengewinde [mm] / Inner Thread [mm]:M15x1,5 Gewindeart: mit Rechtsgewinde / Thread Type: with right-hand thread</p>		<p>16379 45046-29335</p> 
<p>ALL TYPES</p>		
<p>Spurstangenkopf / Tie-rod End Innengewinde [mm] / Inner Thread [mm]:M15x1,5 Gewindeart: mit Rechtsgewinde / Thread Type: with right-hand thread</p>		<p>16380 45047-29075</p> 
<p>ALL TYPES</p>		
<p>Spurstangenkopf / Tie-rod End Gewindeart: mit Rechtsgewinde / Thread Type: with right-hand thread Innengewinde [mm] / Inner Thread [mm]:M14x1,5</p>		<p>24729 45047-29125</p> 
<p>ALL TYPES</p>		
<p>Spurstangenkopf / Tie-rod End Gewindeart: mit Rechtsgewinde / Thread Type: with right-hand thread Innengewinde [mm] / Inner Thread [mm]:M14x1,5 Gewindemaß / Thread Size:M14x1,5</p>		<p>24730 45046-29365</p> 
<p>ALL TYPES</p>		
<p>Axialgelenk, Spurstange / Axial Rod, tie rod für Lenkgetriebe-ID / For steering rack ID:ZF Länge über Alles [mm] / Overall Length [mm]:254 Aussengewinde [mm] / Outer Thread [mm]:M15x1,5</p>		<p>11919 45503-05010</p> 
<p>ALL TYPES</p>		
<p>Axialgelenk, Spurstange / Axial Rod, tie rod für Lenkgetriebe-ID / For steering rack ID:JP Länge über Alles [mm] / Overall Length [mm]:260 Aussengewinde [mm] / Outer Thread [mm]:M15x1,5</p>		<p>11920 45503-29475</p> 
<p>ALL TYPES</p>		
<p>Trag-/Führungsgelenk / Support-/ Steering Link Konusmaß [mm] / Cone Size [mm]:15</p>		<p>16432 43330-29375</p> 
<p>ALL TYPES</p>		
<p>Stange/Strebe, Stabilisator / Rod/Strut, stabiliser Pendelstange / Suspension Rod</p>		<p>16439 48820-05012</p> 
<p>ALL TYPES</p>		









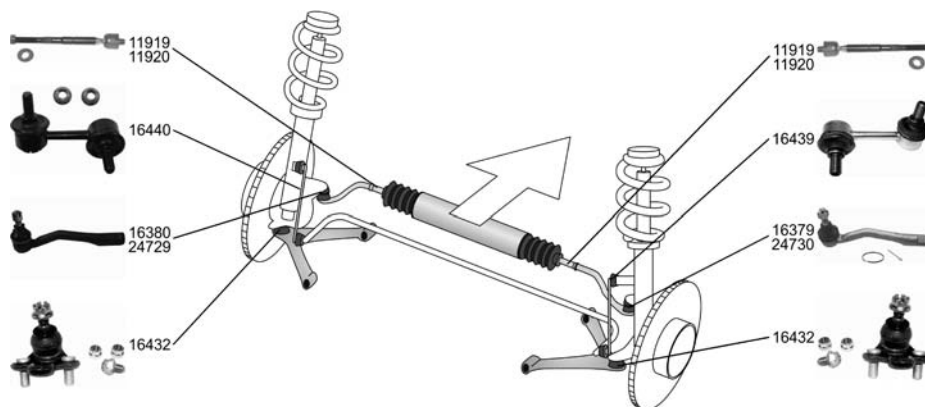

TOYOTA

CARINA E 01.93 - 09.97 Sportswagon/Estate/Break (_T19_)

 Stange/Strebe, Stabilisator / Rod/Strut, stabiliser Pendelstange / Suspension Rod ALL TYPES		16440 48810-05012 
Faltenbalgsatz, Lenkung / Bellow Kit, steering system ALL TYPES	 für / for: Toyota	30227 45535-05010 
Faltenbalgsatz, Lenkung / Bellow Kit, steering system ALL TYPES		30230 45535-12100 
Faltenbalgsatz, Lenkung / Bellow Kit, steering system ALL TYPES	 für / for: Nastech	30240 45535-20080 

CARINA E Stufenheck/Saloon/avec coffre (_T19_) 04.92 - 09.97



Spurstangenkopf / Tie-rod End Innengewinde [mm] / Inner Thread [mm]:M15x1,5 Gewindeart: mit Rechtsgewinde / Thread Type: with right-hand thread ALL TYPES		16379 45046-29335 
Spurstangenkopf / Tie-rod End Innengewinde [mm] / Inner Thread [mm]:M15x1,5 Gewindeart: mit Rechtsgewinde / Thread Type: with right-hand thread ALL TYPES		16380 45047-29075 
Spurstangenkopf / Tie-rod End Gewindeart: mit Rechtsgewinde / Thread Type: with right-hand thread Innengewinde [mm] / Inner Thread [mm]:M14x1,5 ALL TYPES ausser/except for : 2.0 GTi (ST191_) 04.92 - 02.94		24729 45047-29125 
Spurstangenkopf / Tie-rod End Gewindeart: mit Rechtsgewinde / Thread Type: with right-hand thread Innengewinde [mm] / Inner Thread [mm]:M14x1,5 Gewindemaß / Thread Size:M14x1,5 ALL TYPES ausser/except for : 2.0 GTi (ST191_) 04.92 - 02.94		24730 45046-29365 



















OE

TOYOTA



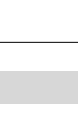

CARINA E Stufenheck/Saloon/avec coffre (_T19_)

04.92 - 09.97

 Axialgelenk, Spurstange / Axial Rod, tie rod für Lenkgetriebe-ID / For steering rack ID:ZF Länge über Alles [mm] / Overall Length [mm]:254 Aussengewinde [mm] / Outer Thread [mm]:M15x1,5		11919 45503-05010 
ALL TYPES ausser/except for : 2.0 GTi (ST191_) 04.92 - 02.94		
Axialgelenk, Spurstange / Axial Rod, tie rod für Lenkgetriebe-ID / For steering rack ID:JP Länge über Alles [mm] / Overall Length [mm]:260 Aussengewinde [mm] / Outer Thread [mm]:M15x1,5		11920 45503-29475 
ALL TYPES ausser/except for : 2.0 GTi (ST191_) 04.92 - 02.94		
Trag-/Führungsgelenk / Support-/ Steering Link Konusmaß [mm] / Cone Size [mm]:15		16432 43330-29375 
ALL TYPES		
Stange/Strebe, Stabilisator / Rod/Strut, stabiliser Pendelstange / Suspension Rod		16439 48820-05012 
ALL TYPES ausser/except for : 2.0 GTi (ST191_) 04.92 - 02.94		
Stange/Strebe, Stabilisator / Rod/Strut, stabiliser Pendelstange / Suspension Rod		16440 48810-05012 
ALL TYPES ausser/except for : 2.0 GTi (ST191_) 04.92 - 02.94		
Faltenbalgsatz, Lenkung / Bellow Kit, steering system		30227 45535-05010 
ALL TYPES	für / for:Toyota	
Faltenbalgsatz, Lenkung / Bellow Kit, steering system		30230 45535-12100 
ALL TYPES		
Faltenbalgsatz, Lenkung / Bellow Kit, steering system		30240 45535-20080 
ALL TYPES	für / for:Nastech	

CELICA Coupe (RA6)

01.82 - 10.86

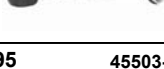
 Spurstange / Tie Rod, steering ALL TYPES		15729 45460-29225 
Axialgelenk, Spurstange / Axial Rod, tie rod Gewindemaß / Thread Size:M14x1,5 Gewindart: mit Rechtsgewinde / Thread Type: with right-hand thread		15195 45503-29125 
ALL TYPES		







OE

TOYOTA

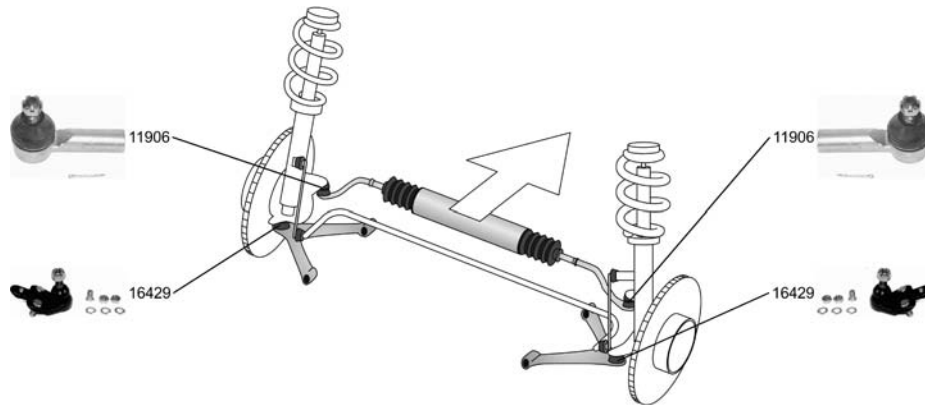
CELICA Cabrio/Convertible (_T16_)

01.87 - 08.90





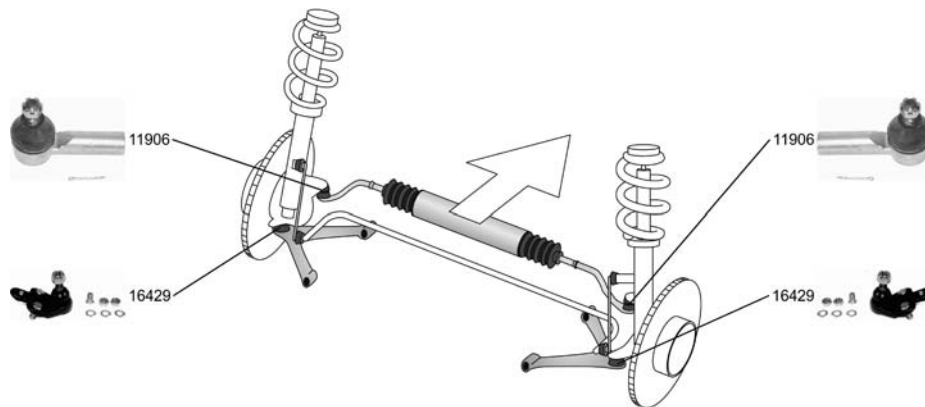

<p>Spurstangenkopf / Tie-rod End Gewindeart: mit Rechtsgewinde / Thread Type: with right-hand thread Gewindemaß / Thread Size:M14x1,5 Innengewinde [mm] / Inner Thread [mm]:M14x1,5 2.0 GT (ST162) 10.86 - 08.90</p>		<p>11906 45046-29305</p> 
<p>Trag-/Führungsgelenk / Support-/ Steering Link Konusmaß [mm] / Cone Size [mm]:15,9 2.0 GT (ST162) 10.86 - 08.90</p>		<p>16429 43330-29185</p> 

CELICA Coupe (T16F)

01.87 - 08.90



<p>Spurstangenkopf / Tie-rod End Gewindeart: mit Rechtsgewinde / Thread Type: with right-hand thread Gewindemaß / Thread Size:M14x1,5 Innengewinde [mm] / Inner Thread [mm]:M14x1,5 ALL TYPES</p>		<p>11906 45046-29305</p> 
<p>Trag-/Führungsgelenk / Support-/ Steering Link Konusmaß [mm] / Cone Size [mm]:15,9 ALL TYPES</p>		<p>16429 43330-29185</p> 







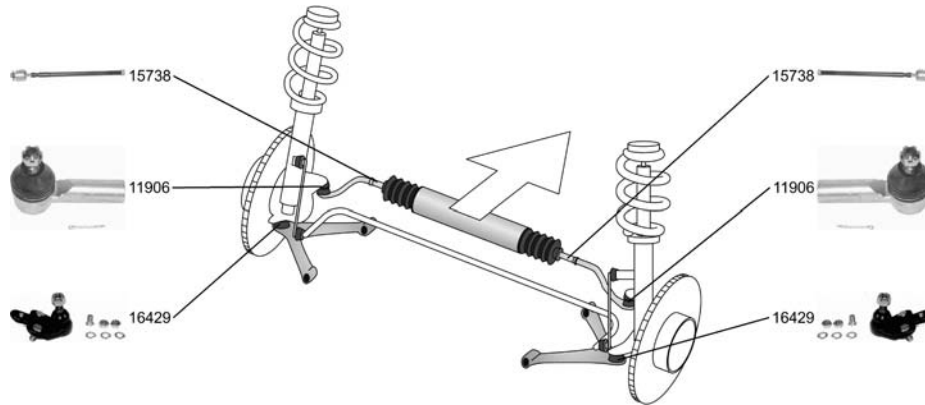

TOYOTA

CELICA Liftback/Hatchback/avec hayon (T16)

08.85 - 08.90





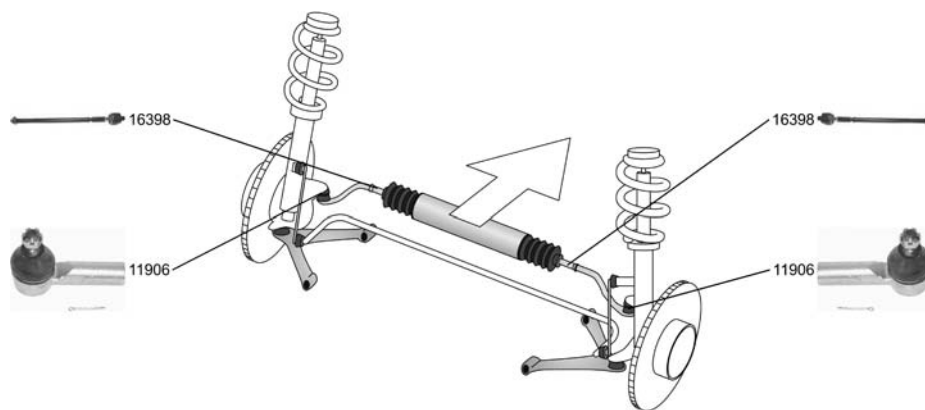

<p>Spurstangenkopf / Tie-rod End Gewindart: mit Rechtsgewinde / Thread Type: with right-hand thread Gewindemaß / Thread Size:M14x1,5 Innengewinde [mm] / Inner Thread [mm]:M14x1,5 ALL TYPES</p>		<p>11906 45046-29305</p> 
<p>Axialgelenk, Spurstange / Axial Rod, tie rod Gewindart: mit Rechtsgewinde / Thread Type: with right-hand thread Gewindemaß / Thread Size:M14x1,5 ALL TYPES</p>		<p>15738 45503-29075</p> 
<p>Trag-/Führungsgelenk / Support-/ Steering Link Konusmaß [mm] / Cone Size [mm]:15,9 ALL TYPES</p>		<p>16429 43330-29185</p> 

CELICA Cabrio/Convertible (_T18_)

05.91 - 01.94





<p>Spurstangenkopf / Tie-rod End Gewindart: mit Rechtsgewinde / Thread Type: with right-hand thread Gewindemaß / Thread Size:M14x1,5 Innengewinde [mm] / Inner Thread [mm]:M14x1,5 ALL TYPES</p>		<p>11906 45046-29305</p> 
<p>Axialgelenk, Spurstange / Axial Rod, tie rod ALL TYPES</p>		<p>16398 45503-29245</p> 



OE





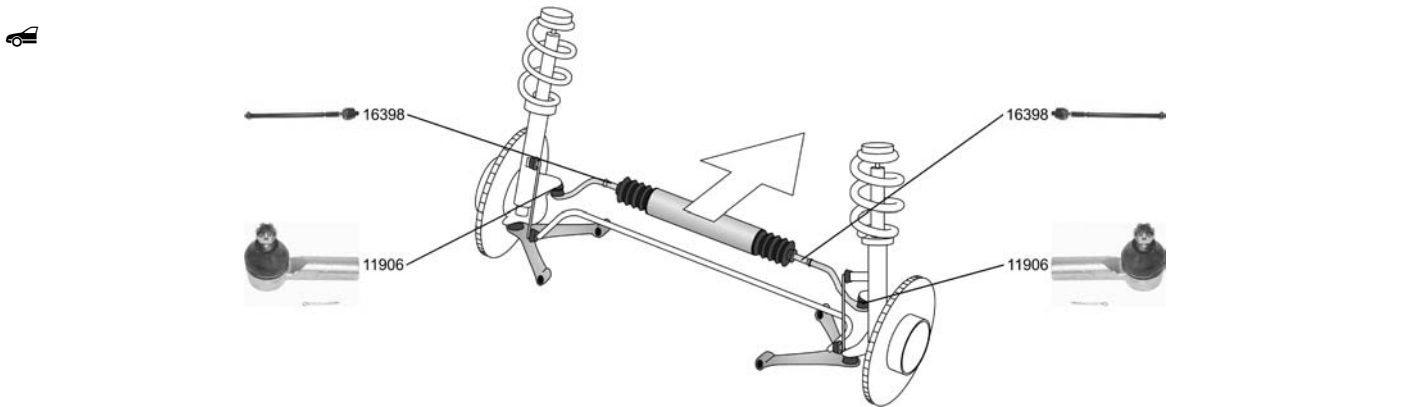

TOYOTA

CELICA Cabrio/Convertible (_T18_) 05.91 - 01.94

 Trag-/Führungsgelenk / Support-/ Steering Link ALL TYPES		15715 43330-29326 
--	---	--

CELICA Coupe (_T18_) 10.89 - 01.94



Spurstangenkopf / Tie-rod End Gewindeart: mit Rechtsgewinde / Thread Type: with right-hand thread Gewindemaß / Thread Size: M14x1,5 Innengewinde [mm] / Inner Thread [mm]: M14x1,5 ALL TYPES		11906 45046-29305 
Axialgelenk, Spurstange / Axial Rod, tie rod ALL TYPES		16398 45503-29245 
Trag-/Führungsgelenk / Support-/ Steering Link ALL TYPES		15715 43330-29326 







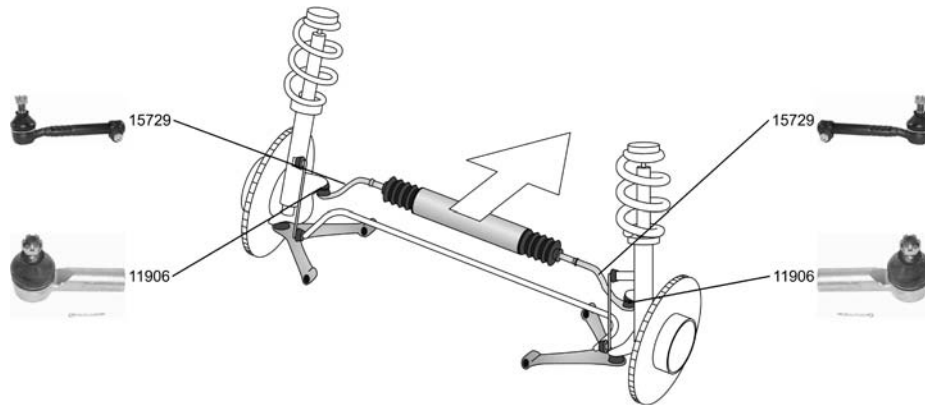

TOYOTA

CELICA (_T20_)

11.93 - 11.99





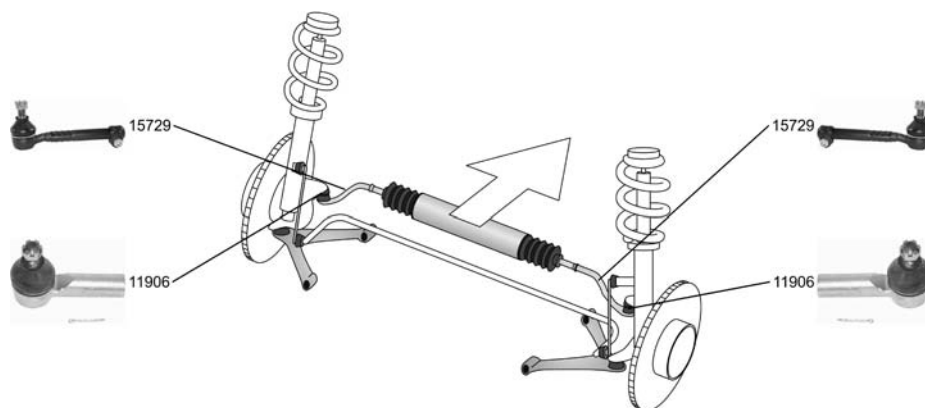

<p>Spurstange / Tie Rod, steering ALL TYPES</p>		<p>15729 45460-29225</p> 
<p>Spurstangenkopf / Tie-rod End Gewindeart: mit Rechtsgewinde / Thread Type: with right-hand thread Gewindemaß / Thread Size:M14x1,5 Innengewinde [mm] / Inner Thread [mm]:M14x1,5 ALL TYPES</p>		<p>11906 45046-29305</p> 
<p>Trag-/Führungsgelenk / Support-/ Steering Link 2.0 i 16V 04.96 - 11.99</p>	 <p>Aggregate/Rollen: anetr. Agg.: Generator / Units / Pulleys: Driven unit: alternator</p>	<p>15715 43330-29326</p> 

CELICA Cabrio/Convertible (_T20_)

11.93 - 11.99





<p>Spurstange / Tie Rod, steering ALL TYPES</p>		<p>15729 45460-29225</p> 
<p>Spurstangenkopf / Tie-rod End Gewindeart: mit Rechtsgewinde / Thread Type: with right-hand thread Gewindemaß / Thread Size:M14x1,5 Innengewinde [mm] / Inner Thread [mm]:M14x1,5 ALL TYPES</p>		<p>11906 45046-29305</p> 



OE

TOYOTA

CELICA Cabrio/Convertible (_T20_) 11.93 - 11.99



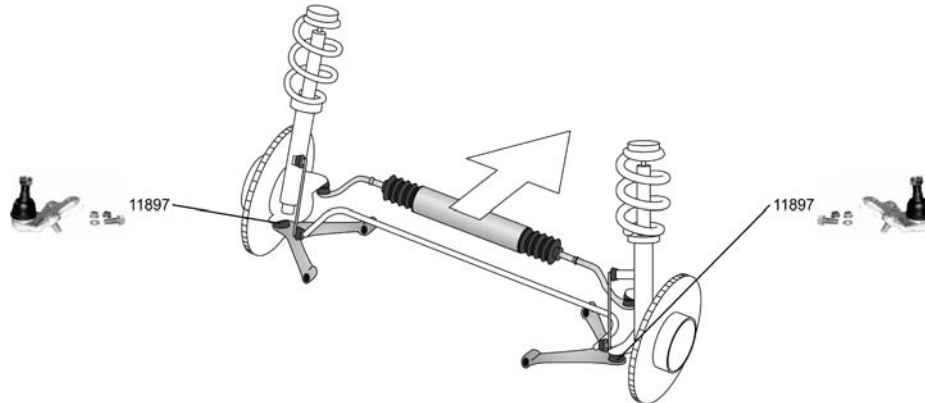

 Trag-/Führungsgelenk / Support-/ Steering Link ALL TYPES	▼	15715 43330-29326
	Aggregate/Rollen: angetr. Agg.: Generator / Units / Pulleys: Driven unit: alternator	
		

CELICA (ZZT23_) 11.99 -



Trag-/Führungsgelenk / Support-/ Steering Link Konusmaß [mm] / Cone Size [mm]:15,9 ALL TYPES	▼ ↻ ♂	11897 43330-29205
		

COROLLA Station Wagon/Estate/Break (_E7_) 12.79 - 08.87















 Spurstangenkopf / Tie-rod End 1.3 (KE70) 12.79 - 08.87 1.8 D (CE70) 05.83 - 08.87	♂	16408 45460-19215
		
Axialgelenk, Spurstange / Axial Rod, tie rod Gewindeart: mit Rechtsgewinde / Thread Type: with right-hand thread Gewindemaß / Thread Size:M14x1,5 1.3 (KE70) 12.79 - 08.87 1.8 D (CE70) 05.83 - 08.87	↻ ♂	11913 45503-19045
		
Axialgelenk, Spurstange / Axial Rod, tie rod Gewindeart: mit Rechtsgewinde / Thread Type: with right-hand thread Gewindemaß / Thread Size:M14x1,5 1.8 D (CE70) 05.83 - 08.87	↻ ♂	11914 45503-19036
		
Trag-/Führungsgelenk / Support-/ Steering Link 1.3 (KE70) 12.79 - 08.87 1.8 D (CE70) 05.83 - 08.87	▼ ↻ ♂	11894 43308-19035
		



TOYOTA





COROLLA (_E8_)

06.83 - 05.88

 Spurstangenkopf / Tie-rod End Gewindeart: mit Rechtsgewinde / Thread Type: with right-hand thread Gewindemaß / Thread Size:M14x1,5 Innengewinde [mm] / Inner Thread [mm]:M14x1,5	1.3 (AE80/EE80)	10.84 - 08.87		11906 45046-29305 
	1.6	12.85 - 05.88		
	1.6 (AE82), 53 kW	08.85 - 08.87		
	1.8 D, 47 kW	07.85 - 05.88		
	1.6 (AE82), 62 kW	06.83 - 08.87		
	1.8 D, 43 kW	06.83 - 05.88		
			09.1984->	
Spurstangenkopf / Tie-rod End Gewindeart: mit Rechtsgewinde / Thread Type: with right-hand thread Gewindemaß / Thread Size:M12x1,25	1.3 (AE80)	06.83 - 10.84		15725 45046-29135 
	1.6 (AE82), 62 kW	06.83 - 08.87		
	1.8 D, 43 kW	06.83 - 05.88		
Axialgelenk, Spurstange / Axial Rod, tie rod Gewindeart: mit Rechtsgewinde / Thread Type: with right-hand thread Gewindemaß / Thread Size:M14x1,5	1.3 (AE80)	06.83 - 10.84		11914 45503-19036 
	1.3 (AE80/EE80)	10.84 - 08.87		
	1.6	12.85 - 05.88		
	1.6 (AE82), 53 kW	08.85 - 08.87		
	1.8 D	06.83 - 05.88		
	1.6 (AE82), 62 kW	06.83 - 08.87		
			 09.1984->	
Axialgelenk, Spurstange / Axial Rod, tie rod Gewindeart: mit Rechtsgewinde / Thread Type: with right-hand thread Gewindemaß / Thread Size:M14x1,5	1.3 (AE80)	06.83 - 10.84		15734 45503-19035 
	1.6 (AE82), 62 kW	06.83 - 08.87		
	1.8 D, 43 kW	06.83 - 05.88		
Trag-/Führungsgelenk / Support-/ Steering Link Konusmaß [mm] / Cone Size [mm]:15,9	ALL TYPES ausser/except for :			11897 43330-29205 
	1.4 (AE 80,81,82)	05.83 - 04.87		
	1.6 (EE 80)	05.83 - 04.87		
Faltenbalsatz, Lenkung / Bellow Kit, steering system	ALL TYPES ausser/except for :			30157 45535-12011 
	1.4 (AE 80,81,82)	05.83 - 04.87		
	1.6 (EE 80)	05.83 - 04.87		

COROLLA Liftback/Hatchback/avec hayon (_E8_)

06.83 - 05.88













 Spurstangenkopf / Tie-rod End Gewindeart: mit Rechtsgewinde / Thread Type: with right-hand thread Gewindemaß / Thread Size:M14x1,5 Innengewinde [mm] / Inner Thread [mm]:M14x1,5	1.3 (EE80)	01.85 - 08.87		11906 45046-29305 
	1.6 (AE82), 54 kW	08.85 - 08.87		
	1.6	07.85 - 05.88		
	1.8 D (CE80)	06.83 - 08.87		
	1.6 (AE82), 62 kW	06.83 - 08.87		
	1.8 D	06.83 - 05.88		
			09.1984->	
Spurstangenkopf / Tie-rod End Gewindeart: mit Rechtsgewinde / Thread Type: with right-hand thread Gewindemaß / Thread Size:M12x1,25	1.3 (AE80)	06.83 - 09.84		15725 45046-29135 
	1.6 (AE82), 62 kW	06.83 - 08.87		
	1.8 D	06.83 - 05.88		
	1.8 D (CE80)	06.83 - 08.87		









OE

TOYOTA





COROLLA Liftback/Hatchback/avec hayon (_E8_) 06.83 - 05.88

 Axialgelenk, Spurstange / Axial Rod, tie rod Gewindeart: mit Rechtsgewinde / Thread Type: with right-hand thread Gewindemaß / Thread Size:M14x1,5			11914 45503-19036 	
	1.3 (AE80)	06.83 - 09.84		
	1.3 (EE80)	01.85 - 08.87		
	1.6 (AE82), 54 kW	08.85 - 08.87		
	1.8 D	06.83 - 05.88		
1.8 D (CE80)	06.83 - 08.87			
1.6 (AE82), 62 kW	06.83 - 08.87	 09.1984->		
1.6	07.85 - 05.88			
Axialgelenk, Spurstange / Axial Rod, tie rod Gewindeart: mit Rechtsgewinde / Thread Type: with right-hand thread Gewindemaß / Thread Size:M14x1,5			15734 45503-19035 	
	1.3 (AE80)	06.83 - 09.84		
	1.6 (AE82), 62 kW	06.83 - 08.87		
	1.8 D	06.83 - 05.88		
	1.8 D (CE80)	06.83 - 08.87		 ->08.1984
Trag-/Führungsgelenk / Support-/ Steering Link Konusmaß [mm] / Cone Size [mm]:15,9			11897 43330-29205 	
	ALL TYPES ausser/except for :			
	1.4 (AE 80,81,82)	05.83 - 04.87		
1.6 (EE 80)	05.83 - 04.87			
Faltenbalgsatz, Lenkung / Bellow Kit, steering system ALL TYPES ausser/except for :			30157 45535-12011 	
	1.4 (AE 80,81,82)	05.83 - 04.87		
	1.6 (EE 80)	05.83 - 04.87		

COROLLA FX Compact (E8B) 08.84 - 05.88

 Spurstangenkopf / Tie-rod End Gewindeart: mit Rechtsgewinde / Thread Type: with right-hand thread Gewindemaß / Thread Size:M14x1,5 Innengewinde [mm] / Inner Thread [mm]:M14x1,5			11906 45046-29305 	
	1.3	08.85 - 08.87		
	1.6 GT 16V	08.85 - 08.87		
1.8 D, 47 kW	08.85 - 08.87			
Axialgelenk, Spurstange / Axial Rod, tie rod Gewindeart: mit Rechtsgewinde / Thread Type: with right-hand thread Gewindemaß / Thread Size:M14x1,5			11914 45503-19036 	
	1.3	08.85 - 08.87		
	1.6 GT 16V	08.85 - 08.87		
1.8 D	01.85 - 05.88			
Trag-/Führungsgelenk / Support-/ Steering Link Konusmaß [mm] / Cone Size [mm]:15,9			11897 43330-29205 	
	1.3	08.85 - 08.87		
	1.6 GT 16V	08.85 - 08.87		
1.8 D	01.85 - 05.88			

COROLLA Coupe (AE86) 05.83 - 07.87







 Spurstangenkopf / Tie-rod End 1.6 GT 16V (AE86)	08.83 - 07.87		16408 45460-19215 
Axialgelenk, Spurstange / Axial Rod, tie rod Gewindeart: mit Rechtsgewinde / Thread Type: with right-hand thread Gewindemaß / Thread Size:M14x1,5			11914 45503-19036 
	1.6 GT 16V (AE86)	08.83 - 07.87	



TOYOTA

COROLLA Coupe (AE86)









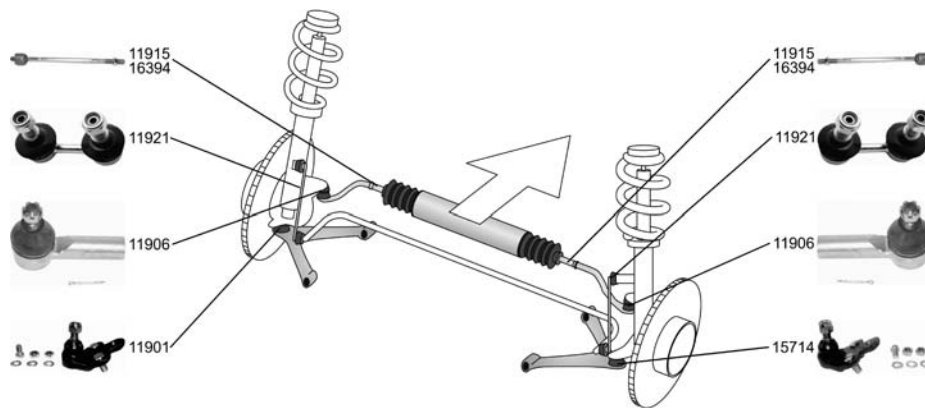



05.83 - 07.87

 Axialgelenk, Spurstange / Axial Rod, tie rod Gewindeart: mit Rechtsgewinde / Thread Type: with right-hand thread Gewindemaß / Thread Size:M14x1,5		15733 45503-19025
		
1.6 GT 16V (AE86) 08.83 - 07.87		
Trag-/Führungsgelenk / Support-/ Steering Link Konusmaß [mm] / Cone Size [mm]:15,9		11897 43330-29205
		
1.6 SR 16V 05.83 - 04.87 1.6 16V 12.85 - 04.87		

COROLLA (_E9_)

07.87 - 06.93



Spurstangenkopf / Tie-rod End Gewindeart: mit Rechtsgewinde / Thread Type: with right-hand thread Gewindemaß / Thread Size:M14x1,5 Innengewinde [mm] / Inner Thread [mm]:M14x1,5		11906 45046-29305
		
ALL TYPES ausser/except for : 1.2 (EE 90) 05.87 - 07.89		
Axialgelenk, Spurstange / Axial Rod, tie rod Gewindeart: mit Rechtsgewinde / Thread Type: with right-hand thread Gewindemaß / Thread Size:M14x1,5		11915 45503-19125
		
ALL TYPES ausser/except for : 1.2 (EE 90) 05.87 - 07.89		
Axialgelenk, Spurstange / Axial Rod, tie rod Gewindeart: mit Rechtsgewinde / Thread Type: with right-hand thread Gewindemaß / Thread Size:M14x1,5		16394 45503-19135
		
ALL TYPES ausser/except for : 1.2 (EE 90) 05.87 - 07.89 1.6 i 4WD 10.87 - 08.90		
Trag-/Führungsgelenk / Support-/ Steering Link Konusmaß [mm] / Cone Size [mm]:15,6		11901 43340-19016
		
ALL TYPES ausser/except for : 1.2 (EE 90) 05.87 - 07.89		
Trag-/Führungsgelenk / Support-/ Steering Link Konusmaß [mm] / Cone Size [mm]:15,6		15714 43330-19066
		
ALL TYPES ausser/except for : 1.2 (EE 90) 05.87 - 07.89		
Stange/Strebe, Stabilisator / Rod/Strut, stabiliser Pendelstange / Suspension Rod		11921 48820-20010
		
ALL TYPES ausser/except for : 1.2 (EE 90) 05.87 - 07.89 1.6 i 4WD 10.87 - 08.90		





OE

TOYOTA

COROLLA (_E9_)









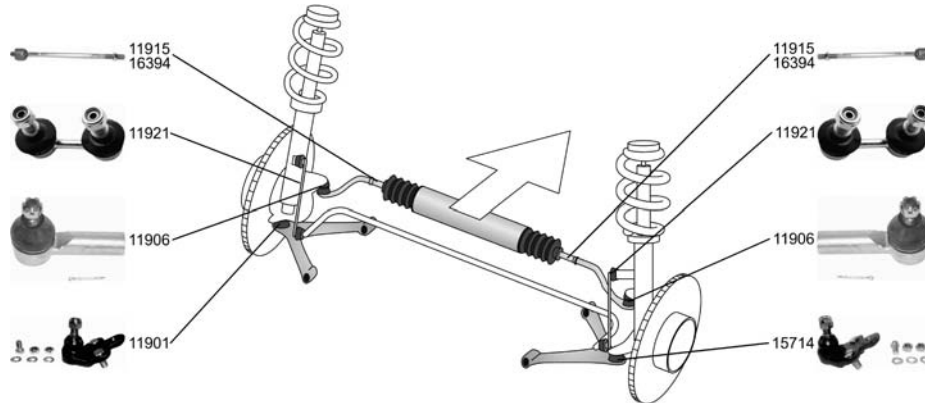





07.87 - 06.93

 Faltenbalgsatz, Lenkung / Bellow Kit, steering system ALL TYPES ausser/except for : 1.2 (EE 90) 1.6 i 4WD		30157 45535-12011 
		05.87 - 07.89 10.87 - 08.90

COROLLA Compact (_E9_)

08.87 - 04.92



Spurstangenkopf / Tie-rod End Gewindeart: mit Rechtsgewinde / Thread Type: with right-hand thread Gewindemaß / Thread Size: M14x1,5 Innengewinde [mm] / Inner Thread [mm]: M14x1,5 ALL TYPES ausser/except for : 1.2 (EE 90)		11906 45046-29305 
05.87 - 07.89		
Axialgelenk, Spurstange / Axial Rod, tie rod Gewindeart: mit Rechtsgewinde / Thread Type: with right-hand thread Gewindemaß / Thread Size: M14x1,5 ALL TYPES ausser/except for : 1.2 (EE 90)		11915 45503-19125 
05.87 - 07.89		
Axialgelenk, Spurstange / Axial Rod, tie rod Gewindeart: mit Rechtsgewinde / Thread Type: with right-hand thread Gewindemaß / Thread Size: M14x1,5 ALL TYPES ausser/except for : 1.2 (EE 90)		16394 45503-19135 
05.87 - 07.89		
Trag-/Führungsgelenk / Support-/ Steering Link Konusmaß [mm] / Cone Size [mm]: 15,6 ALL TYPES ausser/except for : 1.2 (EE 90)		11901 43340-19016 
05.87 - 07.89		
Trag-/Führungsgelenk / Support-/ Steering Link Konusmaß [mm] / Cone Size [mm]: 15,6 ALL TYPES ausser/except for : 1.2 (EE 90)		15714 43330-19066 
05.87 - 07.89		
Stange/Strebe, Stabilisator / Rod/Strut, stabiliser Pendelstange / Suspension Rod ALL TYPES ausser/except for : 1.2 (EE 90)		11921 48820-20010 
05.87 - 07.89		
Faltenbalgsatz, Lenkung / Bellow Kit, steering system ALL TYPES ausser/except for : 1.2 (EE 90)		30157 45535-12011 
05.87 - 07.89		









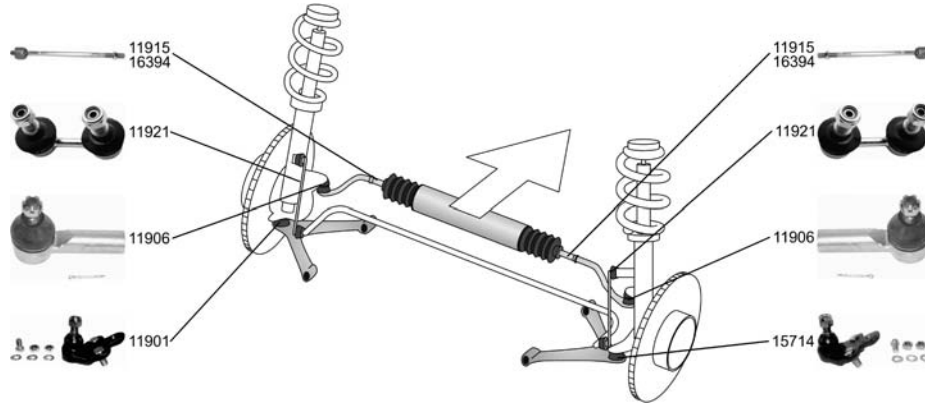







TOYOTA

COROLLA Liftback/Hatchback/avec hayon (_E9_)

07.87 - 06.93



<p>Spurstangenkopf / Tie-rod End Gewindeart: mit Rechtsgewinde / Thread Type: with right-hand thread Gewindemaß / Thread Size:M14x1,5 Innengewinde [mm] / Inner Thread [mm]:M14x1,5 ALL TYPES ausser/except for : 1.2 (EE 90) 05.87 - 07.89</p>		<p>11906 45046-29305</p> 
<p>Axialgelenk, Spurstange / Axial Rod, tie rod Gewindeart: mit Rechtsgewinde / Thread Type: with right-hand thread Gewindemaß / Thread Size:M14x1,5 ALL TYPES ausser/except for : 1.2 (EE 90) 05.87 - 07.89</p>		<p>11915 45503-19125</p> 
<p>Axialgelenk, Spurstange / Axial Rod, tie rod Gewindeart: mit Rechtsgewinde / Thread Type: with right-hand thread Gewindemaß / Thread Size:M14x1,5 ALL TYPES ausser/except for : 1.2 (EE 90) 05.87 - 07.89 1.6 08.87 - 04.92</p>		<p>16394 45503-19135</p> 
<p>Trag-/Führungsgelenk / Support-/ Steering Link Konusmaß [mm] / Cone Size [mm]:15,6 ALL TYPES ausser/except for : 1.2 (EE 90) 05.87 - 07.89</p>		<p>11901 43340-19016</p> 
<p>Trag-/Führungsgelenk / Support-/ Steering Link Konusmaß [mm] / Cone Size [mm]:15,6 ALL TYPES ausser/except for : 1.2 (EE 90) 05.87 - 07.89</p>		<p>15714 43330-19066</p> 
<p>Stange/Strebe, Stabilisator / Rod/Strut, stabiliser Pendelstange / Suspension Rod ALL TYPES ausser/except for : 1.2 (EE 90) 05.87 - 07.89</p>		<p>11921 48820-20010</p> 
<p>Faltenbalgsatz, Lenkung / Bellow Kit, steering system ALL TYPES ausser/except for : 1.2 (EE 90) 05.87 - 07.89</p>		<p>30157 45535-12011</p> 











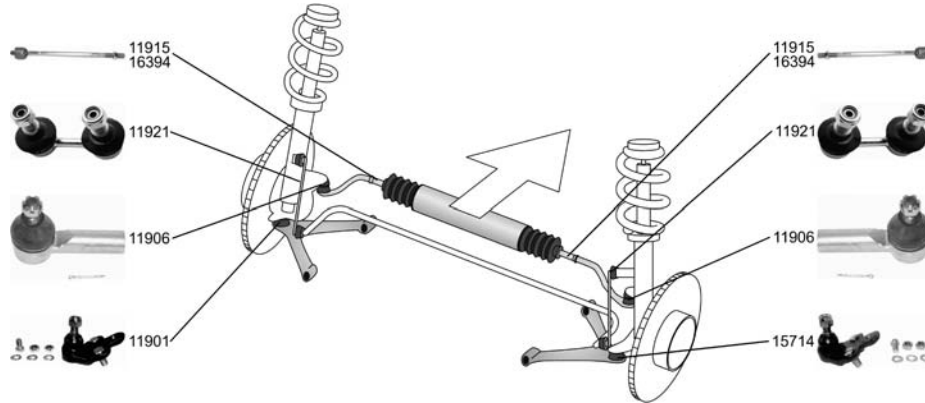



OE

TOYOTA

**COROLLA Station
Wagon/Estate/Break (_E9_)**

12.87 - 12.92





<p>Spurstangenkopf / Tie-rod End Gewindeart: mit Rechtsgewinde / Thread Type: with right-hand thread Gewindemaß / Thread Size: M14x1,5 Innengewinde [mm] / Inner Thread [mm]: M14x1,5</p> <table border="1"> <tr><td>1.3 (EE90)</td><td>12.87 - 12.89</td></tr> <tr><td>1.3 i (EE90)</td><td>06.89 - 06.92</td></tr> <tr><td>1.6 (AE92), 66 kW</td><td>02.88 - 05.92</td></tr> <tr><td>1.6 XLI</td><td>11.89 - 06.92</td></tr> <tr><td>1.6 XLI 4x4 (AE95)</td><td>08.88 - 06.92</td></tr> <tr><td>1.8 D (CE90)</td><td>12.87 - 06.92</td></tr> </table>	1.3 (EE90)	12.87 - 12.89	1.3 i (EE90)	06.89 - 06.92	1.6 (AE92), 66 kW	02.88 - 05.92	1.6 XLI	11.89 - 06.92	1.6 XLI 4x4 (AE95)	08.88 - 06.92	1.8 D (CE90)	12.87 - 06.92		<p>11906 45046-29305</p> 
1.3 (EE90)	12.87 - 12.89													
1.3 i (EE90)	06.89 - 06.92													
1.6 (AE92), 66 kW	02.88 - 05.92													
1.6 XLI	11.89 - 06.92													
1.6 XLI 4x4 (AE95)	08.88 - 06.92													
1.8 D (CE90)	12.87 - 06.92													
<p>Axialgelenk, Spurstange / Axial Rod, tie rod Gewindeart: mit Rechtsgewinde / Thread Type: with right-hand thread Gewindemaß / Thread Size: M14x1,5</p> <table border="1"> <tr><td>1.3 (EE90)</td><td>12.87 - 12.89</td></tr> <tr><td>1.3 i (EE90)</td><td>06.89 - 06.92</td></tr> <tr><td>1.6 (AE92), 66 kW</td><td>02.88 - 05.92</td></tr> <tr><td>1.6 XLI</td><td>11.89 - 06.92</td></tr> <tr><td>1.6 XLI 4x4 (AE95)</td><td>08.88 - 06.92</td></tr> <tr><td>1.8 D (CE90)</td><td>12.87 - 06.92</td></tr> </table>	1.3 (EE90)	12.87 - 12.89	1.3 i (EE90)	06.89 - 06.92	1.6 (AE92), 66 kW	02.88 - 05.92	1.6 XLI	11.89 - 06.92	1.6 XLI 4x4 (AE95)	08.88 - 06.92	1.8 D (CE90)	12.87 - 06.92		<p>11915 45503-19125</p> 
1.3 (EE90)	12.87 - 12.89													
1.3 i (EE90)	06.89 - 06.92													
1.6 (AE92), 66 kW	02.88 - 05.92													
1.6 XLI	11.89 - 06.92													
1.6 XLI 4x4 (AE95)	08.88 - 06.92													
1.8 D (CE90)	12.87 - 06.92													
<p>Axialgelenk, Spurstange / Axial Rod, tie rod Gewindeart: mit Rechtsgewinde / Thread Type: with right-hand thread Gewindemaß / Thread Size: M14x1,5</p> <table border="1"> <tr><td>1.3 (EE90)</td><td>12.87 - 12.89</td></tr> <tr><td>1.3 i (EE90)</td><td>06.89 - 06.92</td></tr> <tr><td>1.6 XLI</td><td>11.89 - 06.92</td></tr> <tr><td>1.6 XLI 4x4 (AE95)</td><td>08.88 - 06.92</td></tr> <tr><td>1.8 D (CE90)</td><td>12.87 - 06.92</td></tr> </table>	1.3 (EE90)	12.87 - 12.89	1.3 i (EE90)	06.89 - 06.92	1.6 XLI	11.89 - 06.92	1.6 XLI 4x4 (AE95)	08.88 - 06.92	1.8 D (CE90)	12.87 - 06.92		<p>16394 45503-19135</p> 		
1.3 (EE90)	12.87 - 12.89													
1.3 i (EE90)	06.89 - 06.92													
1.6 XLI	11.89 - 06.92													
1.6 XLI 4x4 (AE95)	08.88 - 06.92													
1.8 D (CE90)	12.87 - 06.92													
<p>Trag-/Führungsgelenk / Support-/ Steering Link Konusmaß [mm] / Cone Size [mm]: 15,6</p> <table border="1"> <tr><td>1.3 (EE90)</td><td>12.87 - 12.89</td></tr> <tr><td>1.3 i (EE90)</td><td>06.89 - 06.92</td></tr> <tr><td>1.6 (AE92), 66 kW</td><td>02.88 - 05.92</td></tr> <tr><td>1.6 XLI</td><td>11.89 - 06.92</td></tr> <tr><td>1.6 XLI 4x4 (AE95)</td><td>08.88 - 06.92</td></tr> <tr><td>1.8 D (CE90)</td><td>12.87 - 06.92</td></tr> </table>	1.3 (EE90)	12.87 - 12.89	1.3 i (EE90)	06.89 - 06.92	1.6 (AE92), 66 kW	02.88 - 05.92	1.6 XLI	11.89 - 06.92	1.6 XLI 4x4 (AE95)	08.88 - 06.92	1.8 D (CE90)	12.87 - 06.92		<p>11901 43340-19016</p> 
1.3 (EE90)	12.87 - 12.89													
1.3 i (EE90)	06.89 - 06.92													
1.6 (AE92), 66 kW	02.88 - 05.92													
1.6 XLI	11.89 - 06.92													
1.6 XLI 4x4 (AE95)	08.88 - 06.92													
1.8 D (CE90)	12.87 - 06.92													
<p>Trag-/Führungsgelenk / Support-/ Steering Link Konusmaß [mm] / Cone Size [mm]: 15,6</p> <table border="1"> <tr><td>1.3 (EE90)</td><td>12.87 - 12.89</td></tr> <tr><td>1.3 i (EE90)</td><td>06.89 - 06.92</td></tr> <tr><td>1.6 (AE92), 66 kW</td><td>02.88 - 05.92</td></tr> <tr><td>1.6 XLI</td><td>11.89 - 06.92</td></tr> <tr><td>1.6 XLI 4x4 (AE95)</td><td>08.88 - 06.92</td></tr> <tr><td>1.8 D (CE90)</td><td>12.87 - 06.92</td></tr> </table>	1.3 (EE90)	12.87 - 12.89	1.3 i (EE90)	06.89 - 06.92	1.6 (AE92), 66 kW	02.88 - 05.92	1.6 XLI	11.89 - 06.92	1.6 XLI 4x4 (AE95)	08.88 - 06.92	1.8 D (CE90)	12.87 - 06.92		<p>15714 43330-19066</p> 
1.3 (EE90)	12.87 - 12.89													
1.3 i (EE90)	06.89 - 06.92													
1.6 (AE92), 66 kW	02.88 - 05.92													
1.6 XLI	11.89 - 06.92													
1.6 XLI 4x4 (AE95)	08.88 - 06.92													
1.8 D (CE90)	12.87 - 06.92													
<p>Stange/Strebe, Stabilisator / Rod/Strut, stabiliser Pendelstange / Suspension Rod</p> <table border="1"> <tr><td>1.3 (EE90)</td><td>12.87 - 12.89</td></tr> <tr><td>1.3 i (EE90)</td><td>06.89 - 06.92</td></tr> <tr><td>1.6 XLI</td><td>11.89 - 06.92</td></tr> <tr><td>1.6 XLI 4x4 (AE95)</td><td>08.88 - 06.92</td></tr> <tr><td>1.8 D (CE90)</td><td>12.87 - 06.92</td></tr> </table>	1.3 (EE90)	12.87 - 12.89	1.3 i (EE90)	06.89 - 06.92	1.6 XLI	11.89 - 06.92	1.6 XLI 4x4 (AE95)	08.88 - 06.92	1.8 D (CE90)	12.87 - 06.92		<p>11921 48820-20010</p> 		
1.3 (EE90)	12.87 - 12.89													
1.3 i (EE90)	06.89 - 06.92													
1.6 XLI	11.89 - 06.92													
1.6 XLI 4x4 (AE95)	08.88 - 06.92													
1.8 D (CE90)	12.87 - 06.92													



TOYOTA

COROLLA Station Wagon/Estate/Break (_E9_)









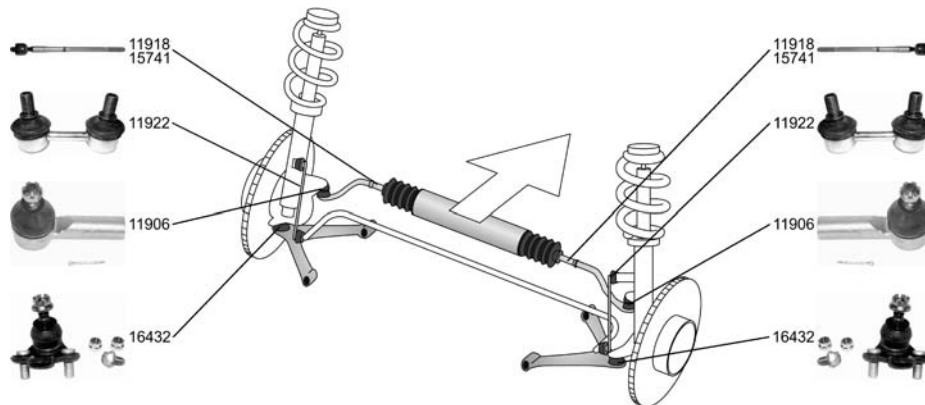







12.87 - 12.92

	Faltenbalgsatz, Lenkung / Bellow Kit, steering system		30157	45535-12011
	1.3 (EE90) 12.87 - 12.89 1.3 i (EE90) 06.89 - 06.92 1.6 XLI 11.89 - 06.92 1.6 XLI 4x4 (AE95) 08.88 - 06.92 1.8 D (CE90) 12.87 - 06.92			

COROLLA (_E10_)

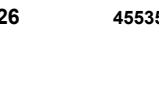
07.92 - 04.97



Spurstangenkopf / Tie-rod End Gewindeart: mit Rechtsgewinde / Thread Type: with right-hand thread Gewindemaß / Thread Size: M14x1,5 Innengewinde [mm] / Inner Thread [mm]: M14x1,5 ALL TYPES		11906	45046-29305
			
Axialgelenk, Spurstange / Axial Rod, tie rod ALL TYPES		11918	45503-29385
			
Axialgelenk, Spurstange / Axial Rod, tie rod ALL TYPES		15741	45503-29365
			
Trag-/Führungsgelenk / Support-/ Steering Link Konusmaß [mm] / Cone Size [mm]: 15 ALL TYPES		16432	43330-29375
			
Stange/Strebe, Stabilisator / Rod/Strut, stabiliser Pendelstange / Suspension Rod		11922	48820-33010
1.3 XLI (EE101_) 09.95 - 04.97 1.3 XLI 16V (EE101) 07.92 - 09.95 1.6 Si (AE101_) 09.95 - 04.97 2.0 D (CE100_) 07.92 - 04.97			
Faltenbalgsatz, Lenkung / Bellow Kit, steering system		30226	45535-12060
1.3 12V (EE100_) 07.92 - 04.97 1.3 XLI (EE101_) 09.95 - 04.97 1.3 XLI 16V (EE101) 07.92 - 09.95 1.6 Si (AE101_) 09.95 - 04.97 2.0 D (CE100_) 07.92 - 04.97			
Faltenbalgsatz, Lenkung / Bellow Kit, steering system		30230	45535-12100
1.3 12V (EE100_) 07.92 - 04.97 1.3 XLI (EE101_) 09.95 - 04.97 1.3 XLI 16V (EE101) 07.92 - 09.95			





OE

TOYOTA

COROLLA (_E10_)







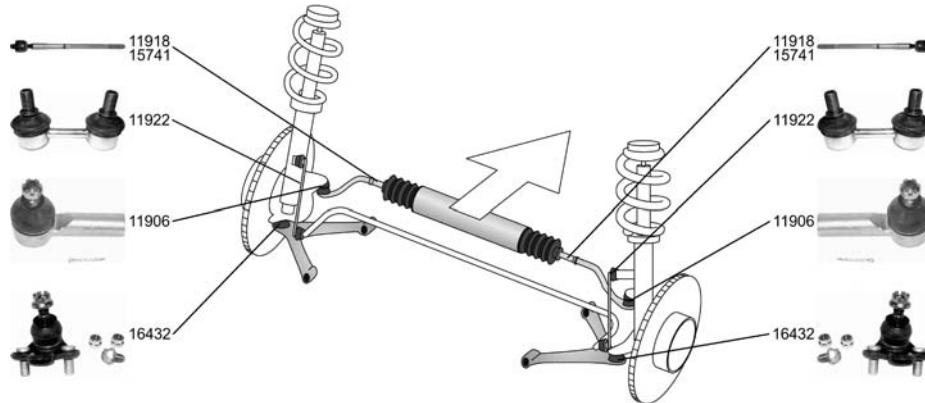

07.92 - 04.97

	Stange/Strebe, Stabilisator / Rod/Strut, stabiliser Pendelstange / Suspension Rod ohne Zubehör / without accessories		14945	48830-20010
	1.3 XLI (EE101_)	09.95 - 04.97		
	1.6 Si (AE101_)	09.95 - 04.97		
	2.0 D (CE100_)	07.92 - 04.97		

COROLLA Compact (_E10_)

07.92 - 04.97





Spurstangenkopf / Tie-rod End Gewindeart: mit Rechtsgewinde / Thread Type: with right-hand thread Gewindemaß / Thread Size: M14x1,5 Innengewinde [mm] / Inner Thread [mm]: M14x1,5 ALL TYPES		11906	45046-29305
Axialgelenk, Spurstange / Axial Rod, tie rod ALL TYPES		11918	45503-29385
Axialgelenk, Spurstange / Axial Rod, tie rod ALL TYPES		15741	45503-29365
Trag-/Führungsgelenk / Support-/ Steering Link Konusmaß [mm] / Cone Size [mm]: 15 ALL TYPES ausser/except for : 2.0 D (CE100_) 07.92 - 04.97		16432	43330-29375
Stange/Strebe, Stabilisator / Rod/Strut, stabiliser Pendelstange / Suspension Rod 1.3 XLI (EE101_) 09.95 - 04.97 1.3 XLI 16V (EE101) 07.92 - 09.95 1.6 Si (AE101_) 07.92 - 04.97 2.0 D (CE100_) 07.92 - 04.97		11922	48820-33010
Faltenbalgsatz, Lenkung / Bellow Kit, steering system 1.3 12V (EE100_) 07.92 - 05.95 1.3 XLI (EE101_) 09.95 - 04.97 1.3 XLI 16V (EE101) 07.92 - 09.95 1.6 Si (AE101_) 07.92 - 04.97 2.0 D (CE100_) 07.92 - 04.97	 	30226	45535-12060
Faltenbalgsatz, Lenkung / Bellow Kit, steering system 1.3 12V (EE100_) 07.92 - 05.95 1.3 XLI (EE101_) 09.95 - 04.97 1.3 XLI 16V (EE101) 07.92 - 09.95 1.8 GT (AE102_) 11.92 - 05.95	 	30230	45535-12100



TOYOTA

COROLLA Compact (_E10_)







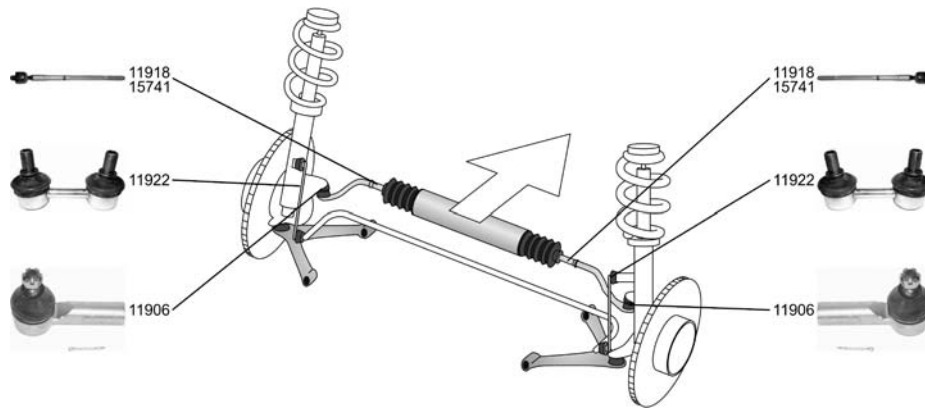

07.92 - 04.97



 Stange/Strebe, Stabilisator / Rod/Strut, stabiliser Pendelstange / Suspension Rod ohne Zubehör / without accessories		14945 48830-20010	
		2.0 D (CE100_) 07.92 - 04.97	

COROLLA Liftback/Hatchback/avec hayon (_E10_)

07.92 - 04.97



Spurstangenkopf / Tie-rod End Gewindart: mit Rechtsgewinde / Thread Type: with right-hand thread Gewindemaß / Thread Size: M14x1,5 Innengewinde [mm] / Inner Thread [mm]: M14x1,5 ALL TYPES		11906 45046-29305	
Axialgelenk, Spurstange / Axial Rod, tie rod 1.3 XLI (EE101_) 07.92 - 04.97 1.6 GLI (AE101_) 07.92 - 04.97 2.0 D (CE100_) 07.92 - 04.97		11918 45503-29385	
Axialgelenk, Spurstange / Axial Rod, tie rod 1.3 XLI (EE101_) 07.92 - 04.97 1.6 GLI (AE101_) 07.92 - 04.97 2.0 D (CE100_) 07.92 - 04.97		15741 45503-29365	
Stange/Strebe, Stabilisator / Rod/Strut, stabiliser Pendelstange / Suspension Rod 1.3 XLI (EE101_) 07.92 - 04.97 1.6 GLI (AE101_) 07.92 - 04.97 2.0 D (CE100_) 07.92 - 04.97		11922 48820-33010	
Faltenbalgsatz, Lenkung / Bellow Kit, steering system 1.3 12V (EE100_) 07.92 - 05.95 1.3 XLI (EE101_) 07.92 - 04.97 1.6 GLI (AE101_) 07.92 - 04.97 2.0 D (CE100_) 07.92 - 04.97		30226 45535-12060	
Faltenbalgsatz, Lenkung / Bellow Kit, steering system 1.3 12V (EE100_) 07.92 - 05.95 1.3 XLI (EE101_) 07.92 - 04.97 1.8 GT (AE102_) 11.92 - 05.95		30230 45535-12100	

 Stange/Strebe, Stabilisator / Rod/Strut, stabiliser Pendelstange / Suspension Rod ohne Zubehör / without accessories		14945 48830-20010	
		2.0 D (CE100_) 07.92 - 04.97	









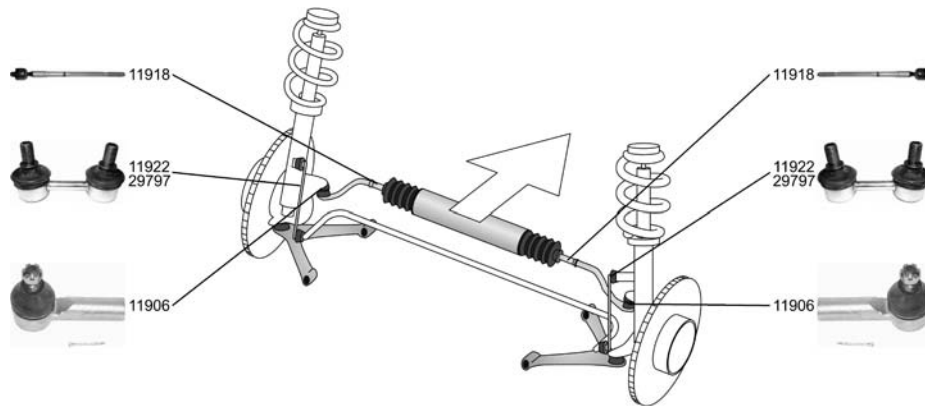





TOYOTA

COROLLA (_E11_)

04.97 - 01.02



<p>Spurstangenkopf / Tie-rod End Gewindart: mit Rechtsgewinde / Thread Type: with right-hand thread Gewindemaß / Thread Size: M14x1,5 Innengewinde [mm] / Inner Thread [mm]: M14x1,5</p> <p>ALL TYPES ausser/except for :</p> <table border="1"> <tr> <td>1.3 12V (EE110)</td> <td>04.97 -</td> </tr> <tr> <td>1.4 (ZZE111)</td> <td>10.99 -</td> </tr> <tr> <td>2.0 D-4D</td> <td>09.00 - 01.02</td> </tr> </table>	1.3 12V (EE110)	04.97 -	1.4 (ZZE111)	10.99 -	2.0 D-4D	09.00 - 01.02		<p>11906 45046-29305</p> 
1.3 12V (EE110)	04.97 -							
1.4 (ZZE111)	10.99 -							
2.0 D-4D	09.00 - 01.02							
<p>Axialgelenk, Spurstange / Axial Rod, tie rod</p> <p>ALL TYPES ausser/except for :</p> <table border="1"> <tr> <td>1.3 12V (EE110)</td> <td>04.97 -</td> </tr> <tr> <td>1.4 (ZZE111)</td> <td>10.99 -</td> </tr> <tr> <td>2.0 D-4D</td> <td>09.00 - 01.02</td> </tr> </table>	1.3 12V (EE110)	04.97 -	1.4 (ZZE111)	10.99 -	2.0 D-4D	09.00 - 01.02		<p>11918 45503-29385</p> 
1.3 12V (EE110)	04.97 -							
1.4 (ZZE111)	10.99 -							
2.0 D-4D	09.00 - 01.02							
<p>Stange/Strebe, Stabilisator / Rod/Strut, stabiliser Pendelstange / Suspension Rod</p> <p>ALL TYPES ausser/except for :</p> <table border="1"> <tr> <td>1.3 12V (EE110)</td> <td>04.97 -</td> </tr> <tr> <td>1.4 (ZZE111)</td> <td>10.99 -</td> </tr> <tr> <td>2.0 D-4D</td> <td>09.00 - 01.02</td> </tr> </table>	1.3 12V (EE110)	04.97 -	1.4 (ZZE111)	10.99 -	2.0 D-4D	09.00 - 01.02		<p>11922 48820-33010</p> 
1.3 12V (EE110)	04.97 -							
1.4 (ZZE111)	10.99 -							
2.0 D-4D	09.00 - 01.02							
<p>Stange/Strebe, Stabilisator / Rod/Strut, stabiliser Pendelstange / Suspension Rod</p> <p>2.0 D-4D 09.00 - 01.02</p>		<p>29797 48820-47010</p> 						
<p>Faltenbalgsatz, Lenkung / Bellow Kit, steering system</p> <p>ALL TYPES ausser/except for :</p> <table border="1"> <tr> <td>1.3 12V (EE110)</td> <td>04.97 -</td> </tr> <tr> <td>1.4 (ZZE111)</td> <td>10.99 -</td> </tr> </table>	1.3 12V (EE110)	04.97 -	1.4 (ZZE111)	10.99 -		<p>30230 45535-12100</p> 		
1.3 12V (EE110)	04.97 -							
1.4 (ZZE111)	10.99 -							
<p> Stange/Strebe, Stabilisator / Rod/Strut, stabiliser Pendelstange / Suspension Rod ohne Zubehör / without accessories</p> <p>ALL TYPES ausser/except for :</p> <table border="1"> <tr> <td>1.3 12V (EE110)</td> <td>04.97 -</td> </tr> <tr> <td>1.4 (ZZE111)</td> <td>10.99 -</td> </tr> <tr> <td>2.0 D-4D</td> <td>09.00 - 01.02</td> </tr> </table>	1.3 12V (EE110)	04.97 -	1.4 (ZZE111)	10.99 -	2.0 D-4D	09.00 - 01.02		<p>14945 48830-20010</p> 
1.3 12V (EE110)	04.97 -							
1.4 (ZZE111)	10.99 -							
2.0 D-4D	09.00 - 01.02							











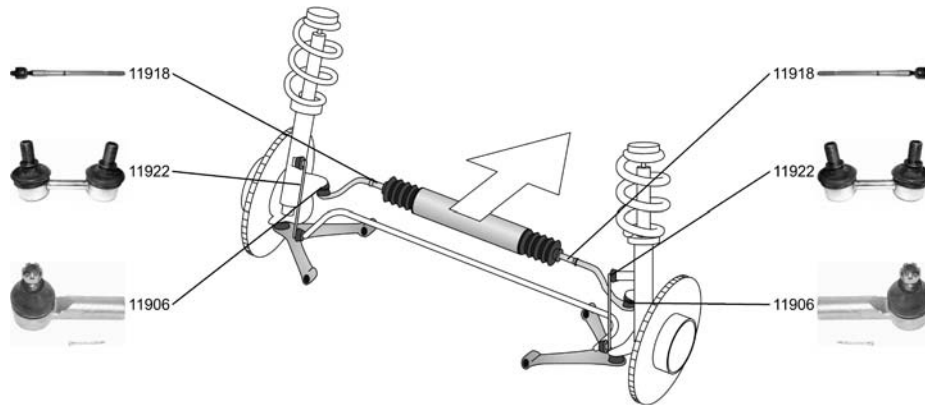

OE

TOYOTA

COROLLA Compact (_E11_)

04.97 - 01.02



<p>Spurstangenkopf / Tie-rod End Gewindeart: mit Rechtsgewinde / Thread Type: with right-hand thread Gewindemaß / Thread Size:M14x1,5 Innengewinde [mm] / Inner Thread [mm]:M14x1,5</p> <p>ALL TYPES ausser/except for :</p> <table border="1"> <tr><td>1.3 12V (EE 110)</td><td>04.97 -</td></tr> <tr><td>1.3 16V (EE 111)</td><td>04.97 -</td></tr> <tr><td>2.0 D-4D</td><td>09.00 - 01.02</td></tr> </table>	1.3 12V (EE 110)	04.97 -	1.3 16V (EE 111)	04.97 -	2.0 D-4D	09.00 - 01.02		<p>11906 45046-29305</p> 
1.3 12V (EE 110)	04.97 -							
1.3 16V (EE 111)	04.97 -							
2.0 D-4D	09.00 - 01.02							
<p>Axialgelenk, Spurstange / Axial Rod, tie rod</p> <p>ALL TYPES ausser/except for :</p> <table border="1"> <tr><td>1.3 12V (EE 110)</td><td>04.97 -</td></tr> <tr><td>1.3 16V (EE 111)</td><td>04.97 -</td></tr> <tr><td>2.0 D-4D</td><td>09.00 - 01.02</td></tr> </table>	1.3 12V (EE 110)	04.97 -	1.3 16V (EE 111)	04.97 -	2.0 D-4D	09.00 - 01.02		<p>11918 45503-29385</p> 
1.3 12V (EE 110)	04.97 -							
1.3 16V (EE 111)	04.97 -							
2.0 D-4D	09.00 - 01.02							
<p>Stange/Strebe, Stabilisator / Rod/Strut, stabiliser Pendelstange / Suspension Rod</p> <p>ALL TYPES ausser/except for :</p> <table border="1"> <tr><td>1.3 12V (EE 110)</td><td>04.97 -</td></tr> <tr><td>1.3 16V (EE 111)</td><td>04.97 -</td></tr> <tr><td>2.0 D-4D</td><td>09.00 - 01.02</td></tr> </table>	1.3 12V (EE 110)	04.97 -	1.3 16V (EE 111)	04.97 -	2.0 D-4D	09.00 - 01.02		<p>11922 48820-33010</p> 
1.3 12V (EE 110)	04.97 -							
1.3 16V (EE 111)	04.97 -							
2.0 D-4D	09.00 - 01.02							
<p>Faltenbaldsatz, Lenkung / Bellow Kit, steering system</p> <p>ALL TYPES ausser/except for :</p> <table border="1"> <tr><td>1.3 12V (EE 110)</td><td>04.97 -</td></tr> <tr><td>1.3 16V (EE 111)</td><td>04.97 -</td></tr> </table>	1.3 12V (EE 110)	04.97 -	1.3 16V (EE 111)	04.97 -		<p>30230 45535-12100</p> 		
1.3 12V (EE 110)	04.97 -							
1.3 16V (EE 111)	04.97 -							
<p>Stange/Strebe, Stabilisator / Rod/Strut, stabiliser Pendelstange / Suspension Rod ohne Zubehör / without accessories</p> <p>ALL TYPES ausser/except for :</p> <table border="1"> <tr><td>1.3 12V (EE 110)</td><td>04.97 -</td></tr> <tr><td>1.3 16V (EE 111)</td><td>04.97 -</td></tr> <tr><td>2.0 D-4D</td><td>09.00 - 01.02</td></tr> </table>	1.3 12V (EE 110)	04.97 -	1.3 16V (EE 111)	04.97 -	2.0 D-4D	09.00 - 01.02		<p>14945 48830-20010</p> 
1.3 12V (EE 110)	04.97 -							
1.3 16V (EE 111)	04.97 -							
2.0 D-4D	09.00 - 01.02							









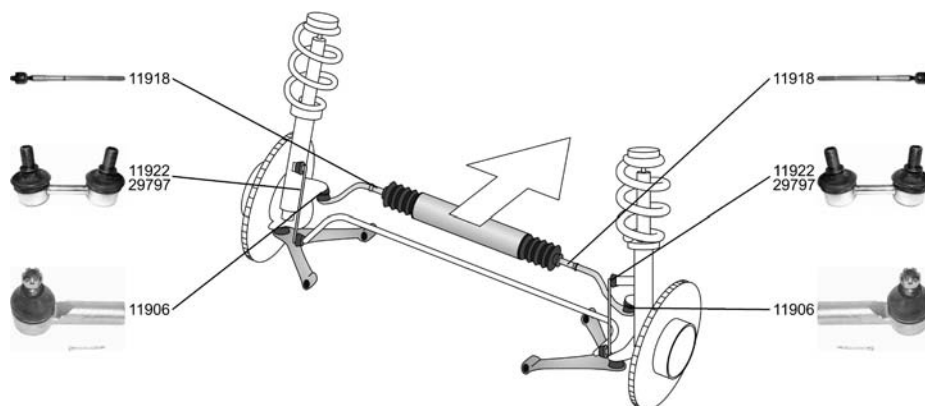





TOYOTA

COROLLA Liftback/Hatchback/avec hayon (_E11_)

04.97 - 01.02



<p>Spurstangenkopf / Tie-rod End Gewindeart: mit Rechtsgewinde / Thread Type: with right-hand thread Gewindemaß / Thread Size: M14x1,5 Innengewinde [mm] / Inner Thread [mm]: M14x1,5</p> <p>ALL TYPES ausser/except for :</p> <table border="1"> <tr> <td>1.3 16V</td> <td>04.97 - 02.00</td> </tr> <tr> <td>2.0 D-4D</td> <td>09.00 - 01.02</td> </tr> </table>	1.3 16V	04.97 - 02.00	2.0 D-4D	09.00 - 01.02		<p>11906 45046-29305</p> 
1.3 16V	04.97 - 02.00					
2.0 D-4D	09.00 - 01.02					
<p>Axialgelenk, Spurstange / Axial Rod, tie rod</p> <p>ALL TYPES ausser/except for :</p> <table border="1"> <tr> <td>1.3 16V</td> <td>04.97 - 02.00</td> </tr> <tr> <td>2.0 D-4D</td> <td>09.00 - 01.02</td> </tr> </table>	1.3 16V	04.97 - 02.00	2.0 D-4D	09.00 - 01.02		<p>11918 45503-29385</p> 
1.3 16V	04.97 - 02.00					
2.0 D-4D	09.00 - 01.02					
<p>Stange/Strebe, Stabilisator / Rod/Strut, stabiliser Pendelstange / Suspension Rod</p> <p>ALL TYPES ausser/except for :</p> <table border="1"> <tr> <td>1.3 16V</td> <td>04.97 - 02.00</td> </tr> <tr> <td>2.0 D-4D</td> <td>09.00 - 01.02</td> </tr> </table>	1.3 16V	04.97 - 02.00	2.0 D-4D	09.00 - 01.02		<p>11922 48820-33010</p> 
1.3 16V	04.97 - 02.00					
2.0 D-4D	09.00 - 01.02					
<p>Stange/Strebe, Stabilisator / Rod/Strut, stabiliser Pendelstange / Suspension Rod</p> <table border="1"> <tr> <td>2.0 D-4D</td> <td>09.00 - 01.02</td> </tr> </table>	2.0 D-4D	09.00 - 01.02		<p>29797 48820-47010</p>		
2.0 D-4D	09.00 - 01.02					
<p>Faltenbalgsatz, Lenkung / Bellow Kit, steering system</p> <p>ALL TYPES ausser/except for :</p> <table border="1"> <tr> <td>1.3 16V</td> <td>04.97 - 02.00</td> </tr> </table>	1.3 16V	04.97 - 02.00		<p>30230 45535-12100</p> 		
1.3 16V	04.97 - 02.00					
<p> Stange/Strebe, Stabilisator / Rod/Strut, stabiliser Pendelstange / Suspension Rod ohne Zubehör / without accessories</p> <p>ALL TYPES ausser/except for :</p> <table border="1"> <tr> <td>1.3 16V</td> <td>04.97 - 02.00</td> </tr> <tr> <td>2.0 D-4D</td> <td>09.00 - 01.02</td> </tr> </table>	1.3 16V	04.97 - 02.00	2.0 D-4D	09.00 - 01.02		<p>14945 48830-20010</p> 
1.3 16V	04.97 - 02.00					
2.0 D-4D	09.00 - 01.02					











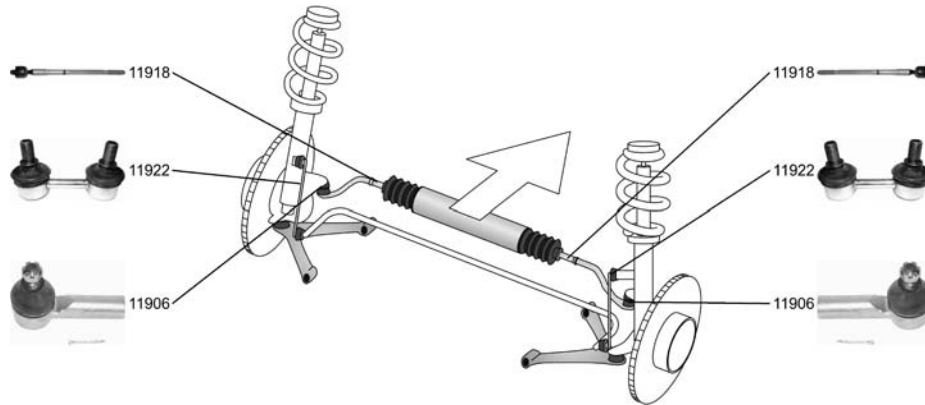



OE

TOYOTA

**COROLLA Wagon/Estate/Break
(_E11_)**

04.97 - 01.02



<p>Spurstangenkopf / Tie-rod End Gewindeart: mit Rechtsgewinde / Thread Type: with right-hand thread Gewindemaß / Thread Size: M14x1,5 Innengewinde [mm] / Inner Thread [mm]: M14x1,5</p> <table border="1"> <tr><td>1.4 (EE111_)</td><td>04.97 - 02.00</td></tr> <tr><td>1.4 16V (ZZE111_)</td><td>02.00 - 01.02</td></tr> <tr><td>1.6 Aut. (AE111_)</td><td>04.97 - 02.00</td></tr> <tr><td>1.6 (AE111_)</td><td>04.97 - 02.00</td></tr> <tr><td>1.6 16V (ZZE112_)</td><td>02.00 - 01.02</td></tr> <tr><td>1.8 AWD (AE115_)</td><td>04.97 - 01.02</td></tr> <tr><td>1.9 D (WZE110_)</td><td>02.00 - 01.02</td></tr> <tr><td>2.0 D (CE110_)</td><td>04.97 - 02.00</td></tr> </table>	1.4 (EE111_)	04.97 - 02.00	1.4 16V (ZZE111_)	02.00 - 01.02	1.6 Aut. (AE111_)	04.97 - 02.00	1.6 (AE111_)	04.97 - 02.00	1.6 16V (ZZE112_)	02.00 - 01.02	1.8 AWD (AE115_)	04.97 - 01.02	1.9 D (WZE110_)	02.00 - 01.02	2.0 D (CE110_)	04.97 - 02.00		<p>11906 45046-29305</p> 
1.4 (EE111_)	04.97 - 02.00																	
1.4 16V (ZZE111_)	02.00 - 01.02																	
1.6 Aut. (AE111_)	04.97 - 02.00																	
1.6 (AE111_)	04.97 - 02.00																	
1.6 16V (ZZE112_)	02.00 - 01.02																	
1.8 AWD (AE115_)	04.97 - 01.02																	
1.9 D (WZE110_)	02.00 - 01.02																	
2.0 D (CE110_)	04.97 - 02.00																	
<p>Axialgelenk, Spurstange / Axial Rod, tie rod</p> <table border="1"> <tr><td>1.4 (EE111_)</td><td>04.97 - 02.00</td></tr> <tr><td>1.4 16V (ZZE111_)</td><td>02.00 - 01.02</td></tr> <tr><td>1.6 Aut. (AE111_)</td><td>04.97 - 02.00</td></tr> <tr><td>1.6 (AE111_)</td><td>04.97 - 02.00</td></tr> <tr><td>1.6 16V (ZZE112_)</td><td>02.00 - 01.02</td></tr> <tr><td>1.8 AWD (AE115_)</td><td>04.97 - 01.02</td></tr> <tr><td>1.9 D (WZE110_)</td><td>02.00 - 01.02</td></tr> <tr><td>2.0 D (CE110_)</td><td>04.97 - 02.00</td></tr> </table>	1.4 (EE111_)	04.97 - 02.00	1.4 16V (ZZE111_)	02.00 - 01.02	1.6 Aut. (AE111_)	04.97 - 02.00	1.6 (AE111_)	04.97 - 02.00	1.6 16V (ZZE112_)	02.00 - 01.02	1.8 AWD (AE115_)	04.97 - 01.02	1.9 D (WZE110_)	02.00 - 01.02	2.0 D (CE110_)	04.97 - 02.00		<p>11918 45503-29385</p> 
1.4 (EE111_)	04.97 - 02.00																	
1.4 16V (ZZE111_)	02.00 - 01.02																	
1.6 Aut. (AE111_)	04.97 - 02.00																	
1.6 (AE111_)	04.97 - 02.00																	
1.6 16V (ZZE112_)	02.00 - 01.02																	
1.8 AWD (AE115_)	04.97 - 01.02																	
1.9 D (WZE110_)	02.00 - 01.02																	
2.0 D (CE110_)	04.97 - 02.00																	
<p>Stange/Strebe, Stabilisator / Rod/Strut, stabiliser Pendelstange / Suspension Rod</p> <table border="1"> <tr><td>1.4 (EE111_)</td><td>04.97 - 02.00</td></tr> <tr><td>1.4 16V (ZZE111_)</td><td>02.00 - 01.02</td></tr> <tr><td>1.6 Aut. (AE111_)</td><td>04.97 - 02.00</td></tr> <tr><td>1.6 (AE111_)</td><td>04.97 - 02.00</td></tr> <tr><td>1.6 16V (ZZE112_)</td><td>02.00 - 01.02</td></tr> <tr><td>1.8 AWD (AE115_)</td><td>04.97 - 01.02</td></tr> <tr><td>1.9 D (WZE110_)</td><td>02.00 - 01.02</td></tr> <tr><td>2.0 D (CE110_)</td><td>04.97 - 02.00</td></tr> </table>	1.4 (EE111_)	04.97 - 02.00	1.4 16V (ZZE111_)	02.00 - 01.02	1.6 Aut. (AE111_)	04.97 - 02.00	1.6 (AE111_)	04.97 - 02.00	1.6 16V (ZZE112_)	02.00 - 01.02	1.8 AWD (AE115_)	04.97 - 01.02	1.9 D (WZE110_)	02.00 - 01.02	2.0 D (CE110_)	04.97 - 02.00		<p>11922 48820-33010</p> 
1.4 (EE111_)	04.97 - 02.00																	
1.4 16V (ZZE111_)	02.00 - 01.02																	
1.6 Aut. (AE111_)	04.97 - 02.00																	
1.6 (AE111_)	04.97 - 02.00																	
1.6 16V (ZZE112_)	02.00 - 01.02																	
1.8 AWD (AE115_)	04.97 - 01.02																	
1.9 D (WZE110_)	02.00 - 01.02																	
2.0 D (CE110_)	04.97 - 02.00																	
<p>Faltenbalsatz, Lenkung / Bellow Kit, steering system</p> <p>ALL TYPES ausser/except for :</p> <table border="1"> <tr><td>1.3 12V (EE 110)</td><td>04.97 -</td></tr> <tr><td>1.3 16V</td><td>04.97 - 02.00</td></tr> <tr><td>1.6 Automatic (AE 111)</td><td>04.97 -</td></tr> </table>	1.3 12V (EE 110)	04.97 -	1.3 16V	04.97 - 02.00	1.6 Automatic (AE 111)	04.97 -		<p>30230 45535-12100</p> 										
1.3 12V (EE 110)	04.97 -																	
1.3 16V	04.97 - 02.00																	
1.6 Automatic (AE 111)	04.97 -																	
<p> Stange/Strebe, Stabilisator / Rod/Strut, stabiliser Pendelstange / Suspension Rod ohne Zubehör / without accessories</p> <table border="1"> <tr><td>1.4 (EE111_)</td><td>04.97 - 02.00</td></tr> <tr><td>1.4 16V (ZZE111_)</td><td>02.00 - 01.02</td></tr> <tr><td>1.6 Aut. (AE111_)</td><td>04.97 - 02.00</td></tr> <tr><td>1.6 (AE111_)</td><td>04.97 - 02.00</td></tr> <tr><td>1.6 16V (ZZE112_)</td><td>02.00 - 01.02</td></tr> <tr><td>1.8 AWD (AE115_)</td><td>04.97 - 01.02</td></tr> <tr><td>1.9 D (WZE110_)</td><td>02.00 - 01.02</td></tr> <tr><td>2.0 D (CE110_)</td><td>04.97 - 02.00</td></tr> </table>	1.4 (EE111_)	04.97 - 02.00	1.4 16V (ZZE111_)	02.00 - 01.02	1.6 Aut. (AE111_)	04.97 - 02.00	1.6 (AE111_)	04.97 - 02.00	1.6 16V (ZZE112_)	02.00 - 01.02	1.8 AWD (AE115_)	04.97 - 01.02	1.9 D (WZE110_)	02.00 - 01.02	2.0 D (CE110_)	04.97 - 02.00		<p>14945 48830-20010</p> 
1.4 (EE111_)	04.97 - 02.00																	
1.4 16V (ZZE111_)	02.00 - 01.02																	
1.6 Aut. (AE111_)	04.97 - 02.00																	
1.6 (AE111_)	04.97 - 02.00																	
1.6 16V (ZZE112_)	02.00 - 01.02																	
1.8 AWD (AE115_)	04.97 - 01.02																	
1.9 D (WZE110_)	02.00 - 01.02																	
2.0 D (CE110_)	04.97 - 02.00																	









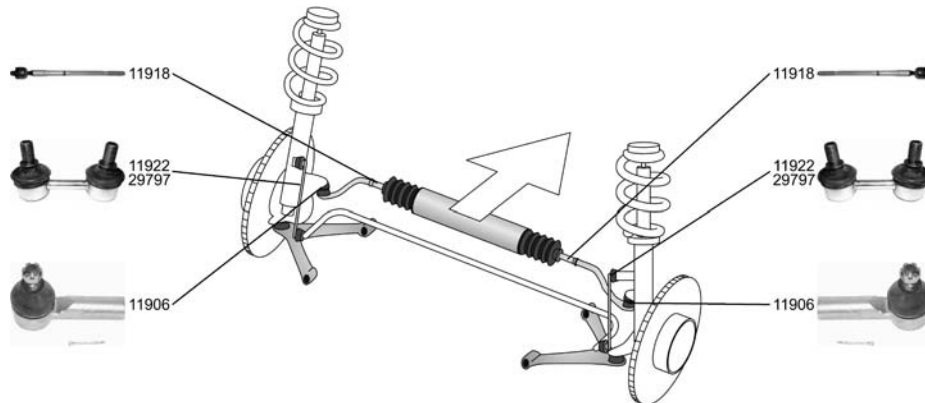



TOYOTA

COROLLA (_E12U_)

01.02 -



<p>Spurstangenkopf / Tie-rod End Gewindeart: mit Rechtsgewinde / Thread Type: with right-hand thread Gewindemaß / Thread Size: M14x1,5 Innengewinde [mm] / Inner Thread [mm]: M14x1,5 2.0 D-4D, 81 kW 01.02 -</p>		<p>11906 45046-29305</p> 
<p>Axialgelenk, Spurstange / Axial Rod, tie rod 2.0 D-4D, 81 kW 01.02 -</p>		<p>11918 45503-29385</p> 
<p>Stange/Strebe, Stabilisator / Rod/Strut, stabiliser Pendelstange / Suspension Rod 2.0 D-4D, 81 kW 01.02 -</p>		<p>11922 48820-33010</p> 
<p>Stange/Strebe, Stabilisator / Rod/Strut, stabiliser Pendelstange / Suspension Rod ALL TYPES ausser/except for : 1.4 D 07.04 - 1.8 VVTL-i TS, 165 kW 02.05 -</p>		<p>29797 48820-47010</p>
<p> Stange/Strebe, Stabilisator / Rod/Strut, stabiliser Pendelstange / Suspension Rod ohne Zubehör / without accessories 2.0 D-4D, 81 kW 01.02 -</p>		<p>14945 48830-20010</p> 





OE

TOYOTA

**COROLLA Combi/Estate/Break
(_E12J_)**

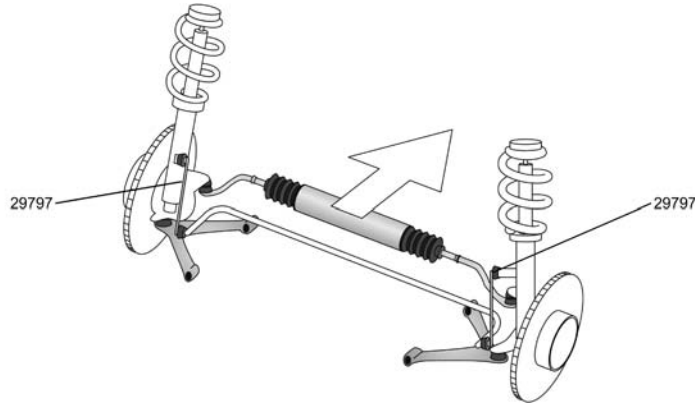
01.02 -



Stange/Strebe, Stabilisator / Rod/Strut, stabiliser Pendelstange / Suspension Rod		29797	48820-47010
1.4 VVT-i	01.02 -		
1.6 VVT-i	01.02 -		
2.0 D-4D	01.02 -		

**COROLLA Stufenheck/Saloon/avec
coffre (_E12_)**

08.02 -

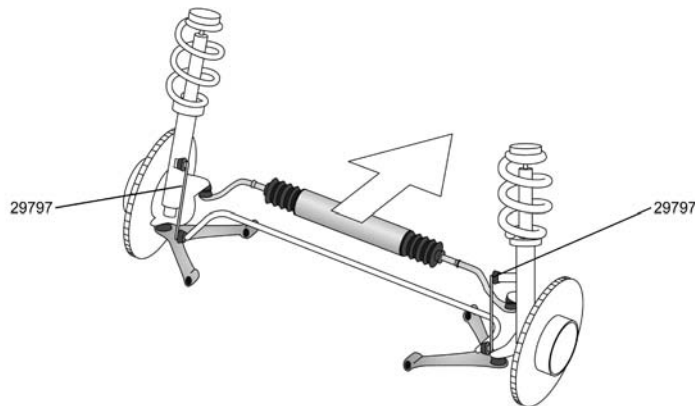

Stange/Strebe, Stabilisator / Rod/Strut, stabiliser Pendelstange / Suspension Rod		29797	48820-47010
1.4 VVT-i	08.02 -		
1.6 VVT-i	08.02 -		



TOYOTA

COROLLA Verso (_E12J_)

01.02 - 05.04

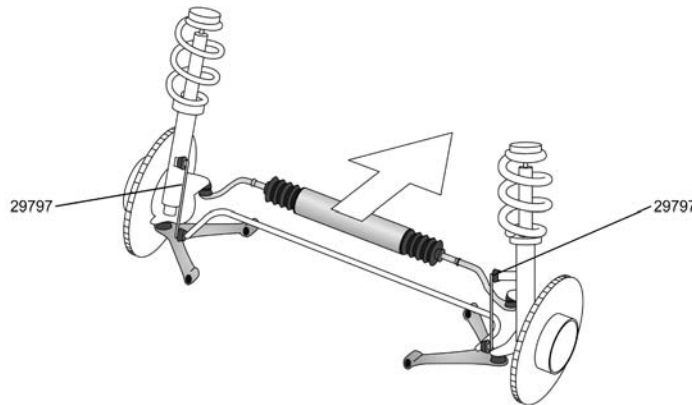

Stange/Strebe, Stabilisator / Rod/Strut, stabiliser Pendelstange / Suspension Rod		29797	48820-47010
1.6 VVT-i	01.02 - 05.04		
1.8 VVT-i	01.02 - 05.04		
2.0 D-4D	01.02 - 05.04		

COROLLA Verso

04.04 -











Stange/Strebe, Stabilisator / Rod/Strut, stabiliser Pendelstange / Suspension Rod		29797	48820-47010
1.6	04.04 -		
1.8	04.04 -		
2.0 D-4D	04.04 -		

HIACE II Kasten/Box/Furgón/Van (H5_)

03.83 - 11.89











Spurstangenkopf / Tie-rod End Gewindeart: mit Linksgewinde / Thread Type: With left-hand thread Gewindemaß / Thread Size:M17x1,5 Aussengewinde [mm] / Outer Thread [mm]:M17x1,5 ALL TYPES		11907	45046-39235	
Spurstangenkopf / Tie-rod End 2.0		16353	45047-39065	
01.84 - 11.89				
Spurstangenkopf / Tie-rod End Gewindeart: mit Rechtsgewinde / Thread Type: with right-hand thread Gewindemaß / Thread Size:M17x1,5 ALL TYPES		16361	45406-29145	
Trag-/Führungsgelenk / Support-/ Steering Link ALL TYPES		11896	43330-29155	
Trag-/Führungsgelenk / Support-/ Steering Link Konusmaß [mm] / Cone Size [mm]:17,2 ALL TYPES		11905	43350-29056	



OE





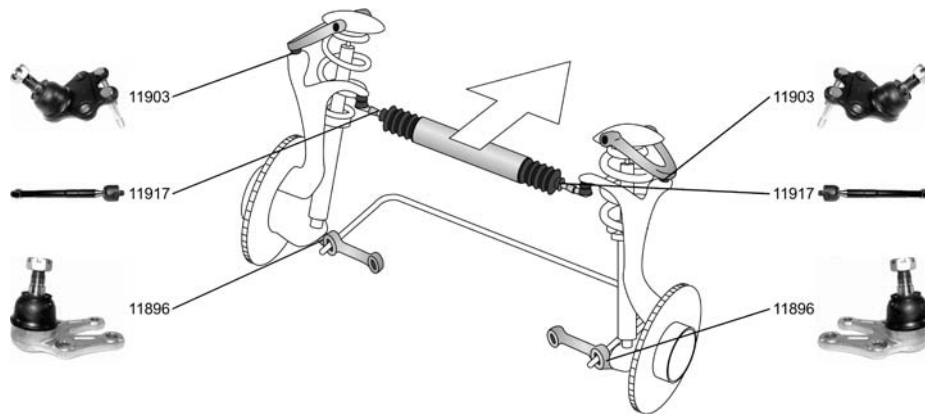

TOYOTA

HIACE II Wagon/Bus/Familial (H5_) 03.83 - 11.89

 Spurstangenkopf / Tie-rod End Gewindeart: mit Linksgewinde / Thread Type: With left-hand thread Gewindemaß / Thread Size:M17x1,5 Aussengewinde [mm] / Outer Thread [mm]:M17x1,5 ALL TYPES		11907 45046-39235 
Spurstangenkopf / Tie-rod End Gewindeart: mit Rechtsgewinde / Thread Type: with right-hand thread Gewindemaß / Thread Size:M17x1,5 ALL TYPES		16361 45406-29145 
Trag-/Führungsgelenk / Support-/ Steering Link ALL TYPES		11896 43330-29155 
Trag-/Führungsgelenk / Support-/ Steering Link Konusmaß [mm] / Cone Size [mm]:17,2 ALL TYPES		11905 43350-29056 

HIACE III Kasten/Box/Furgón/Van (_H10_) 08.89 - 08.95



Axialgelenk, Spurstange / Axial Rod, tie rod 2.0 02.90 - 08.95 2.4 08.89 - 08.95 2.4 Diesel 02.90 - 08.95		11917 45503-29255 
Trag-/Führungsgelenk / Support-/ Steering Link 2.0 02.90 - 08.95 2.4 08.89 - 08.95 2.4 4WD 08.89 - 08.95 2.4 Diesel 02.90 - 08.95		11896 43330-29155 
Trag-/Führungsgelenk / Support-/ Steering Link Konusmaß [mm] / Cone Size [mm]:17,2 2.0 02.90 - 08.95 2.4 08.89 - 08.95 2.4 4WD 08.89 - 08.95 2.4 Diesel 02.90 - 08.95		11903 43350-29065 







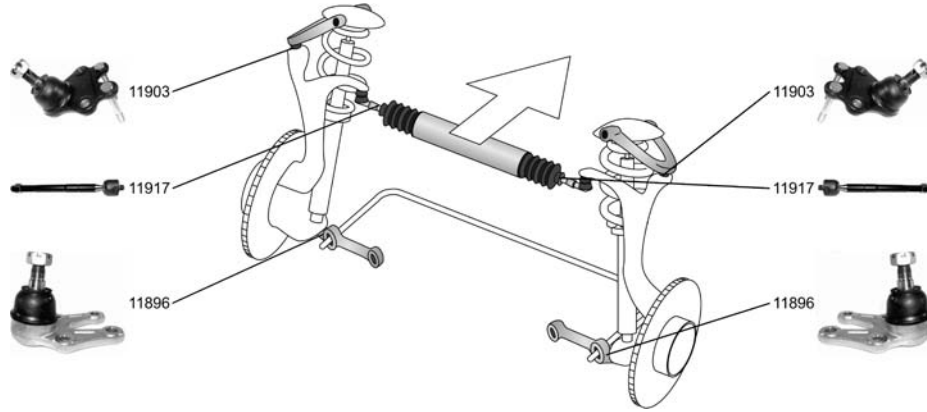

TOYOTA

**HIACE III Wagon/Bus/Familial
(_H10_)**

08.89 - 08.95





<p>Axialgelenk, Spurstange / Axial Rod, tie rod</p> <p>2.0 (RZH102) 08.89 - 08.95 2.4 (RZH103) 08.89 - 08.95 2.4 D (LH102) 08.89 - 08.95 2.4 D 10.93 - 08.95</p>		<p>11917 45503-29255</p> 
<p>Trag-/Führungsgelenk / Support-/ Steering Link</p> <p>ALL TYPES ausser/except for : 2.4 D 4WD 08.89 - 08.95</p>		<p>11896 43330-29155</p> 
<p>Trag-/Führungsgelenk / Support-/ Steering Link</p> <p>Konusmaß [mm] / Cone Size [mm]:17,2</p> <p>ALL TYPES ausser/except for : 2.4 D 4WD 08.89 - 08.95</p>		<p>11903 43350-29065</p> 

**HIACE IV Kasten/Box/Furgón/Van
(_H1_, _H2_)**

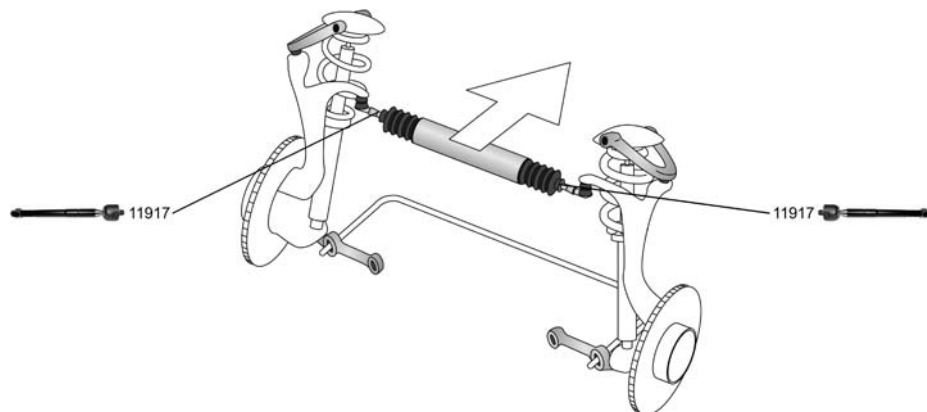
08.95 -



<p>Axialgelenk, Spurstange / Axial Rod, tie rod</p> <p>2.4 (RCH12_, RCH22_) 08.95 - 04.98 2.4 D (LXH12_, LXH22_) 08.95 - 2.4 TD (LXH12_, LXH22_) 08.95 -</p>		<p>11917 45503-29255</p> 
---	---	---





OE

TOYOTA

**HIACE IV Wagon/Bus/Familial
(_H1_,_H2_)**

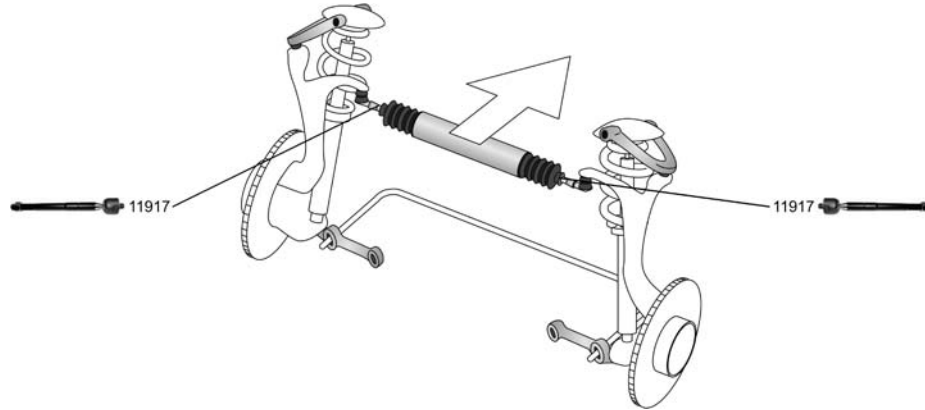
08.95 -







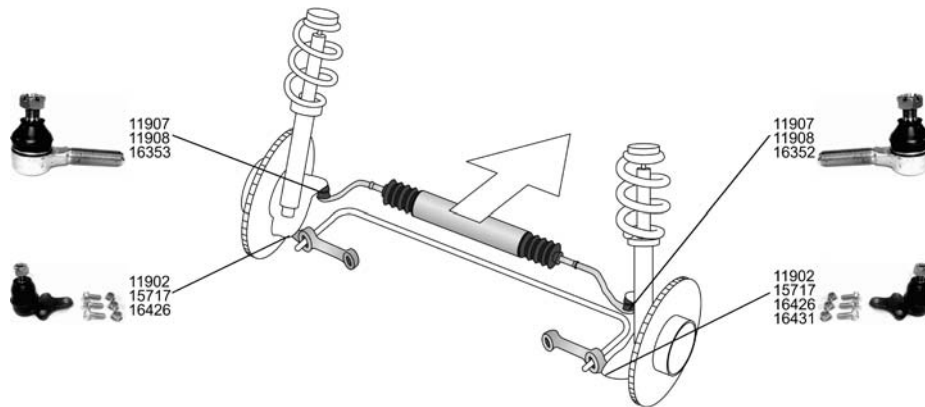

Axialgelenk, Spurstange / Axial Rod, tie rod		11917 45503-29255
2.4 (RCH12_, RCH22_)	08.95 - 04.98	
2.4 D, 58 kW	08.95 -	
2.4 TD (LXH12_, LXH22_)	08.95 -	

HILUX Pickup (_N_)

01.84 -













Spurstangenkopf / Tie-rod End Gewindeart: mit Linksgewinde / Thread Type: With left-hand thread Gewindemaß / Thread Size:M17x1,5 Aussengewinde [mm] / Outer Thread [mm]:M17x1,5		11907 45046-39235
1.8 (YN85_, YN90_)	08.88 - 07.94	
2.0	01.84 - 12.86	
2.2 4WD (YN106_, YN110_)	01.87 - 12.89	
2.4 i 4WD	06.89 - .	
2.4 D 4WD	08.88 - .	
2.4 TD 4WD	08.98 - 01.02	
Spurstangenkopf / Tie-rod End Gewindeart: mit Rechtsgewinde / Thread Type: with right-hand thread Gewindemaß / Thread Size:M17x1,5 Aussengewinde [mm] / Outer Thread [mm]:M17x1,5		11908 45406-39155
1.8 (YN85_, YN90_)	08.88 - 07.94	
2.0	01.84 - 12.86	
2.4 i 4WD	06.89 - .	
2.4 D 4WD, 58 kW	01.94 -	
2.4 D	08.88 - 01.02	
2.4 TD 4WD	08.98 - 01.02	
Spurstangenkopf / Tie-rod End		16352 45046-39095
2.0	01.84 - 12.86	



TOYOTA











HILUX Pickup (_N_)

01.84 -

	Spurstangenkopf / Tie-rod End		16353	45047-39065
	2.0	01.84 - 12.86		
	Trag-/Führungsgelenk / Support-/ Steering Link		11902	43330-39295
	Konusmaß [mm] / Cone Size [mm]:18,2			
	1.8 (YN85_, YN90_)	08.88 - 07.94		
	2.0	01.84 - 12.86		
	2.4 D, 58 kW	03.95 -		
	2.4 D, 59 kW	01.92 -		
	2.4 D, 61 kW	08.88 -		
	Trag-/Führungsgelenk / Support-/ Steering Link		15717	43360-39085
	Konusmaß [mm] / Cone Size [mm]:17,1			
	2.2 4WD (YN106_, YN110_)	01.87 - 12.89		
	2.4 i 4WD, 84 kW, 2355 ccm	06.89 -		
	2.4 i 4WD, 103 kW	08.97 -		
	2.4 D 4WD	08.88 -		
	2.4 TD 4WD	08.98 - 01.02		
	Trag-/Führungsgelenk / Support-/ Steering Link		16426	43350-39115
	1.8 (YN85_, YN90_)	08.88 - 07.94		
	2.0	01.84 - 12.86		
	2.4 D	08.88 - 01.02		
	Trag-/Führungsgelenk / Support-/ Steering Link		16431	43330-39265
	2.4 i 4WD	06.89 -		
	2.4 D 4WD, 58 kW	01.94 -		
	2.4 TD 4WD	08.98 - 01.02		
	2.2 4WD (YN106_, YN110_)	01.87 - 12.89		
	2.4 D 4WD, 61 kW	08.88 -		
		04.1989->		

LAND CRUISER (_J6_)

10.81 - 12.89

	Spurstangenkopf / Tie-rod End		16352	45046-39095
	3.4 Diesel (BJ60_V)	10.81 - 08.87		
	Spurstangenkopf / Tie-rod End		16353	45047-39065
	3.4 Diesel (BJ60_V)	10.81 - 08.87		
	Spurstangenkopf / Tie-rod End		16371	45046-69055
	Gewindart: mit Linksgewinde / Thread Type: With left-hand thread			
	Gewindemaß / Thread Size:M21x1,5			
	Aussengewinde [mm] / Outer Thread [mm]:M21x1,5			
	4.0 (FJ62_G)	08.87 - 12.89		
	4.2 (FJ60_V)	10.81 - 01.88		
	4.0 Diesel (HJ60)	01.82 - 12.87		
	4.0 Diesel (HJ60_V)	10.81 - 01.88		
	4.0 Turbo-D (HJ61_V)	10.85 - 12.89		
	Spurstangenkopf / Tie-rod End		16372	45047-69065
	Gewindart: mit Rechtsgewinde / Thread Type: with right-hand thread			
	Gewindemaß / Thread Size:M23x1,5			
	Aussengewinde [mm] / Outer Thread [mm]:M23x1,5			
	4.0 (FJ62_G)	08.87 - 12.89		
	4.2 (FJ60_V)	10.81 - 01.88		
	4.0 Diesel (HJ60)	01.82 - 12.87		
	4.0 Diesel (HJ60_V)	10.81 - 01.88		
	4.0 Turbo-D (HJ61_V)	10.85 - 12.89		
	Spurstangenkopf / Tie-rod End		16373	45046-69115
	Gewindart: mit Linksgewinde / Thread Type: With left-hand thread			
	Gewindemaß / Thread Size:M23x1,5			
	4.0 (FJ62_G)	08.87 - 12.89		
	4.2 (FJ60_V)	10.81 - 01.88		
	4.0 Diesel (HJ60)	01.82 - 12.87		
	4.0 Diesel (HJ60_V)	10.81 - 01.88		
	4.0 Turbo-D (HJ61_V)	10.85 - 12.89		







OE

TOYOTA

LAND CRUISER (_J6_)







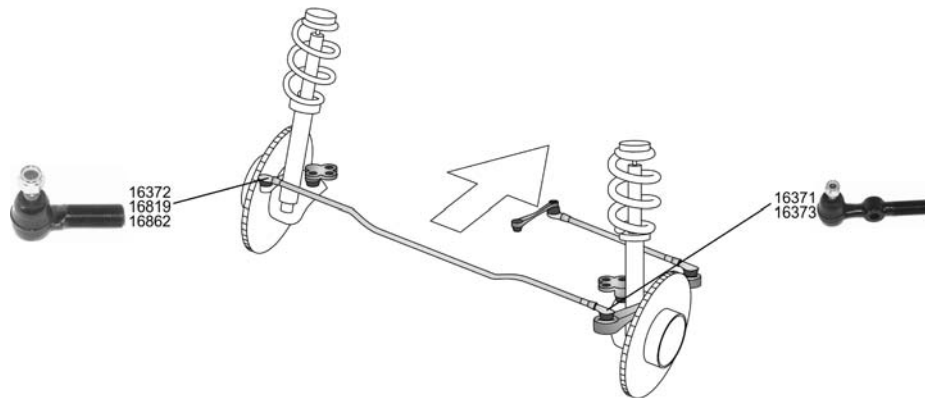

10.81 - 12.89

 Spurstangenkopf / Tie-rod End Gewindeart: mit Linksgewinde / Thread Type: With left-hand thread Gewindemaß / Thread Size:M21x1,5		22680 45044-69055	
		4.0 (FJ62_G) 08.87 - 12.89	
		4.2 (FJ60_V) 10.81 - 01.88	
		4.0 Diesel (HJ60) 01.82 - 12.87	
		4.0 Diesel (HJ60_V) 10.81 - 01.88 4.0 Turbo-D (HJ61_V) 10.85 - 12.89	
Spurstangenkopf / Tie-rod End Gewindeart: mit Rechtsgewinde / Thread Type: with right-hand thread Gewindemaß / Thread Size:M21x1,5		22682 45045-69045	
		4.0 (FJ62_G) 08.87 - 12.89	
		4.2 (FJ60_V) 10.81 - 01.88	
		4.0 Diesel (HJ60) 01.82 - 12.87	
		4.0 Diesel (HJ60_V) 10.81 - 01.88 4.0 Turbo-D (HJ61_V) 10.85 - 12.89	

LAND CRUISER (_J7_)

11.84 -





Spurstangenkopf / Tie-rod End Gewindeart: mit Linksgewinde / Thread Type: With left-hand thread Gewindemaß / Thread Size:M21x1,5 Aussengewinde [mm] / Outer Thread [mm]:M21x1,5		16371 45046-69055	
		2.4 (RJ70_, RJ73_) 11.84 - 05.93	
		2.4 (RJ70_V, RJ73_V) 12.88 - 12.96	
		2.4 D (LJ70_) 11.84 - 10.85	
		2.4 TD (LJ70_, LJ73_) 10.85 - 05.90	
		2.4 TD (LJ70) 01.90 - 05.93 3.0 TD (KZJ70_, KZJ73_, KZJ77_) 05.93 - 05.96	
Spurstangenkopf / Tie-rod End Gewindeart: mit Rechtsgewinde / Thread Type: with right-hand thread Gewindemaß / Thread Size:M23x1,5 Aussengewinde [mm] / Outer Thread [mm]:M23x1,5		16372 45047-69065	
		2.4 (RJ70_, RJ73_) 11.84 - 05.93	
		2.4 (RJ70_V, RJ73_V) 12.88 - 12.96	
		2.4 D (LJ70_) 11.84 - 10.85	
		2.4 TD (LJ70_, LJ73_) 10.85 - 05.90	
		2.4 TD (LJ70) 01.90 - 05.93 3.0 TD (KZJ70_, KZJ73_, KZJ77_) 05.93 - 05.96	
Spurstangenkopf / Tie-rod End Gewindeart: mit Linksgewinde / Thread Type: With left-hand thread Gewindemaß / Thread Size:M23x1,5		16373 45046-69115	
		2.4 (RJ70_, RJ73_) 11.84 - 05.93	
		2.4 (RJ70_V, RJ73_V) 12.88 - 12.96	
		2.4 D (LJ70_) 11.84 - 10.85	
		2.4 TD (LJ70_, LJ73_) 10.85 - 05.90	
		2.4 TD (LJ70) 01.90 - 05.93 3.0 TD (KZJ70_, KZJ73_, KZJ77_) 05.93 - 05.96	
Spurstangenkopf / Tie-rod End Gewindeart: mit Rechtsgewinde / Thread Type: with right-hand thread Gewindemaß / Thread Size:M21x1,5		16819 45045-69065	
		2.4 (RJ70_V, RJ73_V) 12.88 - 12.96	
		2.4 TD (LJ70) 01.90 - 05.93	
		3.0 TD (KZJ70_, KZJ73_, KZJ77_) 05.93 - 05.96	
		3.4 D (BJ70_V, BJ73_) 11.84 - 12.96	



TOYOTA

LAND CRUISER (_J7_)





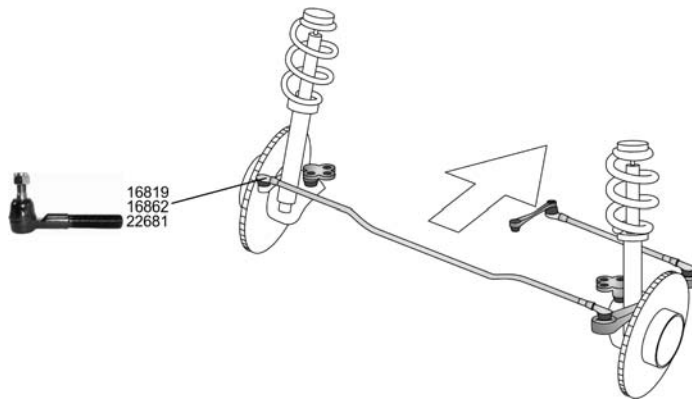

11.84 -

 Spurstangenkopf / Tie-rod End Gewindeart: mit Rechtsgewinde / Thread Type: with right-hand thread Gewindemaß / Thread Size:M23x1,5		16862 45047-69085	
			
			2.4 (RJ70_V, RJ73_V) 12.88 - 12.96
			2.4 TD (LJ70) 01.90 - 05.93
3.0 TD (KZJ70_, KZJ73_, KZJ77_) 05.93 - 05.96			
3.4 D (BJ70_V, BJ73_) 11.84 - 12.96			
Faltenbalgsatz, Lenkung / Bellow Kit, steering system		30236 45535-60010	
3.0 TD (KZJ70_, KZJ73_, KZJ77_) 05.93 - 05.96			

LAND CRUISER Hardtop/open off-road vehicle/carrosserie ouverte (_J7_)

07.90 - 05.96



Spurstangenkopf / Tie-rod End Gewindeart: mit Rechtsgewinde / Thread Type: with right-hand thread Gewindemaß / Thread Size:M21x1,5 ALL TYPES	LHD/RHD 	16819 45045-69065
		
Spurstangenkopf / Tie-rod End Gewindeart: mit Rechtsgewinde / Thread Type: with right-hand thread Gewindemaß / Thread Size:M23x1,5 ALL TYPES		16862 45047-69085
		
Spurstangenkopf / Tie-rod End ALL TYPES		22681 45044-69085
		
Faltenbalgsatz, Lenkung / Bellow Kit, steering system		30236 45535-60010
3.0 TD 05.93 - 05.96		







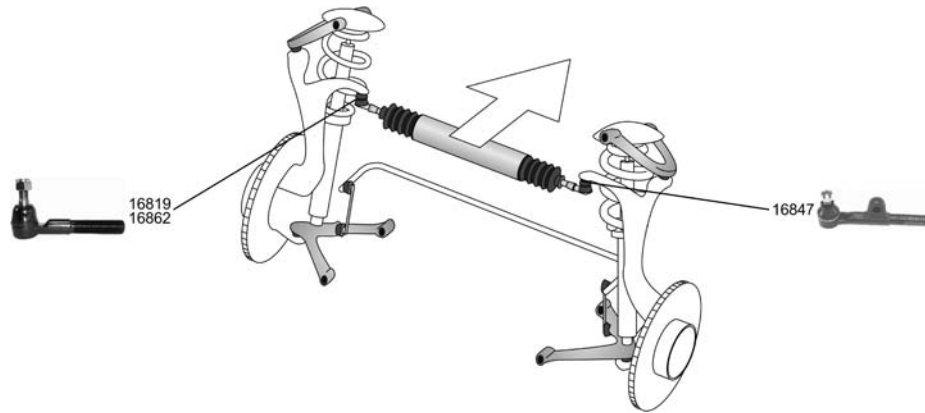

OE

TOYOTA

LAND CRUISER 80 (_J8_)

01.90 - 12.97



Spurstangenkopf / Tie-rod End Gewindeart: mit Rechtsgewinde / Thread Type: with right-hand thread Gewindemaß / Thread Size:M21x1,5	LHD RHD 	16819 45045-69065
ALL TYPES ausser/except for : KZJ (80) 08.92 - 12.98 4.2 D (HZJ80) 01.90 - 4.2 D (HZJ80_) 01.90 - 12.97		
Spurstangenkopf / Tie-rod End Gewindeart: mit Linksgewinde / Thread Type: With left-hand thread Gewindemaß / Thread Size:M21x1,5	LHD 	16847 45044-69125
ALL TYPES ausser/except for : KZJ (80) 08.92 - 12.98 4.2 D (HZJ80) 01.90 - 4.2 D (HZJ80_) 01.90 - 12.97		
Spurstangenkopf / Tie-rod End Gewindeart: mit Rechtsgewinde / Thread Type: with right-hand thread Gewindemaß / Thread Size:M23x1,5		16862 45047-69085
ALL TYPES ausser/except for : KZJ (80) 08.92 - 12.98 4.2 D (HZJ80) 01.90 - 4.2 D (HZJ80_) 01.90 - 12.97		
Faltenbalgsatz, Lenkung / Bellow Kit, steering system 4.5 24V (FZJ80_) 08.92 - 12.97 4.2 TD (HDJ80) 01.90 - 12.97 4.2 TD 24V (HDJ80_) 03.95 - 12.97		30236 45535-60010

LAND CRUISER 90 (_J9_)

04.96 -



Faltenbalgsatz, Lenkung / Bellow Kit, steering system 3.4 i 24V (VZJ90_, VZJ95_) 04.96 - 3.0 TD (KZJ90_, KZJ95_) 04.96 - 3.0 D-4D 10.00 -		30236 45535-60010
--	--	---------------------------------

LAND CRUISER 100 (_J10_)

01.98 -





Faltenbalgsatz, Lenkung / Bellow Kit, steering system ALL TYPES		30236 45535-60010
---	--	---------------------------------

LITEACE Kasten/Box/Furgón/Van (M2_V)

10.79 - 10.86









Spurstangenkopf / Tie-rod End Gewindeart: mit Linksgewinde / Thread Type: With left-hand thread Gewindemaß / Thread Size:M14x1,5		15719 45046-29155
1.3 10.79 - 10.86		



TOYOTA

LITEACE Kasten/Box/Furgón/Van (M2_V)







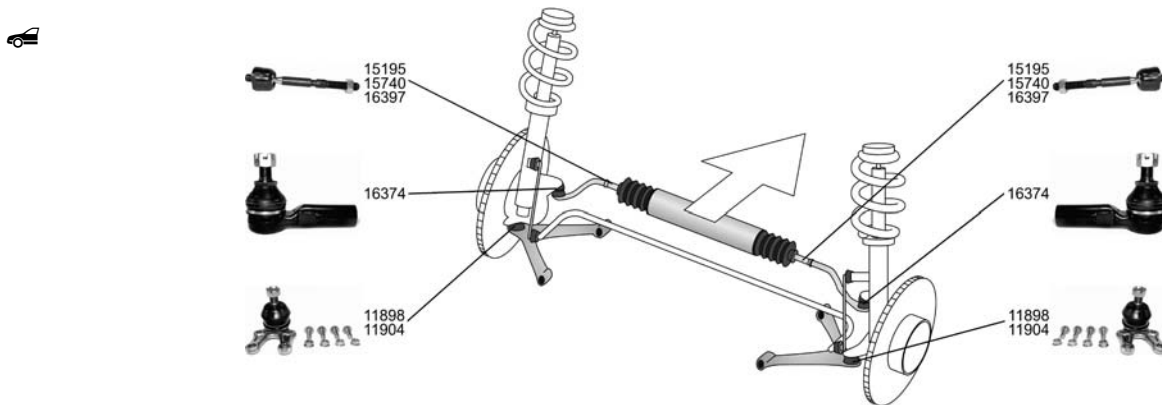

10.79 - 10.86

	Trag-/Führungsgelenk / Support-/ Steering Link		11898 43330-29245
	1.3	10.79 - 10.86	01.1982->
	Trag-/Führungsgelenk / Support-/ Steering Link		11904 43350-29036
	1.3	10.79 - 10.86	
	Trag-/Führungsgelenk / Support-/ Steering Link		15191 43330-29095
	1.3	10.79 - 10.86	

LITEACE Bus/Familial (CM30_G, KM30_G)

10.85 - 01.92







Spurstangenkopf / Tie-rod End		16374 45046-29186
1.5 (KM30LG), 52 kW	07.89 - 01.92	
Axialgelenk, Spurstange / Axial Rod, tie rod		15195 45503-29125
Gewindemaß / Thread Size:M14x1,5 Gewindeart: mit Rechtsgewinde / Thread Type: with right-hand thread		
1.5 (KM30LG), 51 kW	10.85 - 08.89	
2.0 D (CM30LG)	08.88 - 01.92	
1.5 (KM30LG), 52 kW	07.89 - 01.92	
Axialgelenk, Spurstange / Axial Rod, tie rod		15740 45503-29135
Gewindeart: mit Rechtsgewinde / Thread Type: with right-hand thread Gewindemaß / Thread Size:M14x1,5		
1.5 (KM30LG), 51 kW	10.85 - 08.89	->08.1988
Axialgelenk, Spurstange / Axial Rod, tie rod		16397 45503-29215
1.5 (KM30LG), 52 kW	07.89 - 01.92	



OE









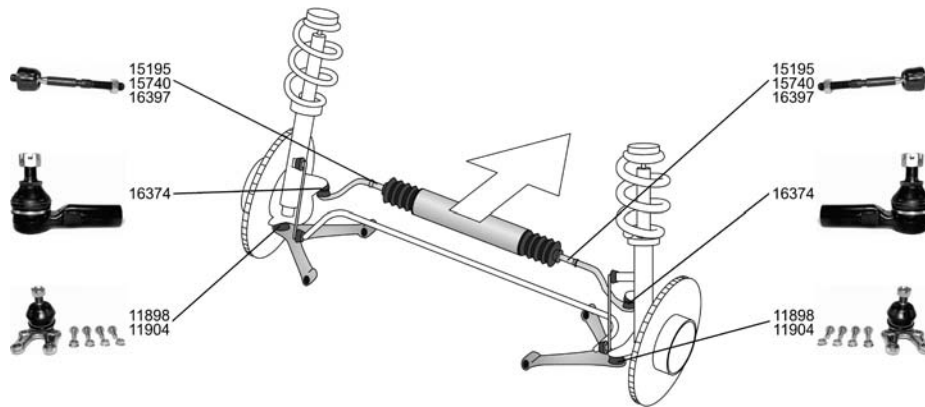



TOYOTA

LITEACE Bus/Familial (CM30_G, KM30_G) 10.85 - 01.92

	Trag-/Führungsgelenk / Support-/ Steering Link		11898	43330-29245
	1.5 (KM30LG)	10.85 - 01.92		
	Trag-/Führungsgelenk / Support-/ Steering Link		11904	43350-29036
	1.5 (KM30LG)	10.85 - 01.92		

LITEACE Kasten/Box/Furgón/Van (CM3_V, KM3_V) 10.85 - 01.92





	Spurstangenkopf / Tie-rod End		16374	45046-29186
	1.5 (KM31_V, KM36_V)	05.86 - 09.91		
	Axialgelenk, Spurstange / Axial Rod, tie rod		15195	45503-29125
	Gewindemaß / Thread Size: M14x1,5 Gewindeart: mit Rechtsgewinde / Thread Type: with right-hand thread			
	1.5 (KM31_V, KM36_V) 05.86 - 09.91 1.8 D (CM35_V) 10.85 - 08.88 2.0 D (CM36_V) 08.88 - 01.92			
	Axialgelenk, Spurstange / Axial Rod, tie rod		15740	45503-29135
	Gewindeart: mit Rechtsgewinde / Thread Type: with right-hand thread Gewindemaß / Thread Size: M14x1,5			
1.5 (KM31_V, KM36_V)	05.86 - 09.91	->08.1988		
	Axialgelenk, Spurstange / Axial Rod, tie rod		16397	45503-29215
	1.5 (KM31_V, KM36_V)	05.86 - 09.91		
	Trag-/Führungsgelenk / Support-/ Steering Link		11898	43330-29245
	1.5 (KM31_V, KM36_V)	05.86 - 09.91		



TOYOTA















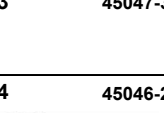

**LITEACE Kasten/Box/Furgón/Van
(CM3_V, KM3_V)**

10.85 - 01.92

	Trag-/Führungsgelenk / Support-/ Steering Link		11904	43350-29036	
	1.5 (KM31_V, KM36_V)	05.86 - 09.91			

MODELL F Bus/Familial (_R2_, 31)

11.82 - 01.90

	Spurstangenkopf / Tie-rod End Gewindeart: mit Linksgewinde / Thread Type: With left-hand thread Gewindemaß / Thread Size:M14x1,5		15719	45046-29155	
	ALL TYPES				
	Spurstangenkopf / Tie-rod End 2.0 Super (YR21)		16352	45046-39095	
	08.84 - 08.88	Baumuster / Model:YY61 08.1987->			
	Spurstangenkopf / Tie-rod End 2.0 Super (YR21)		16353	45047-39065	
	08.84 - 08.88	Baumuster / Model:YY61 08.1987->			
	Spurstangenkopf / Tie-rod End 2.0 (YR21_G)		16374	45046-29186	
	08.88 - 01.90				
	Axialgelenk, Spurstange / Axial Rod, tie rod Gewindeart: mit Rechtsgewinde / Thread Type: with right-hand thread Gewindemaß / Thread Size:M14x1,5		15740	45503-29135	
	2.0 Super (YR21)	08.84 - 08.88			
	Axialgelenk, Spurstange / Axial Rod, tie rod 2.0 (YR21_G)		16397	45503-29215	
	08.88 - 01.90				
	Trag-/Führungsgelenk / Support-/ Steering Link ALL TYPES		11898	43330-29245	
	Trag-/Führungsgelenk / Support-/ Steering Link ALL TYPES		11904	43350-29036	







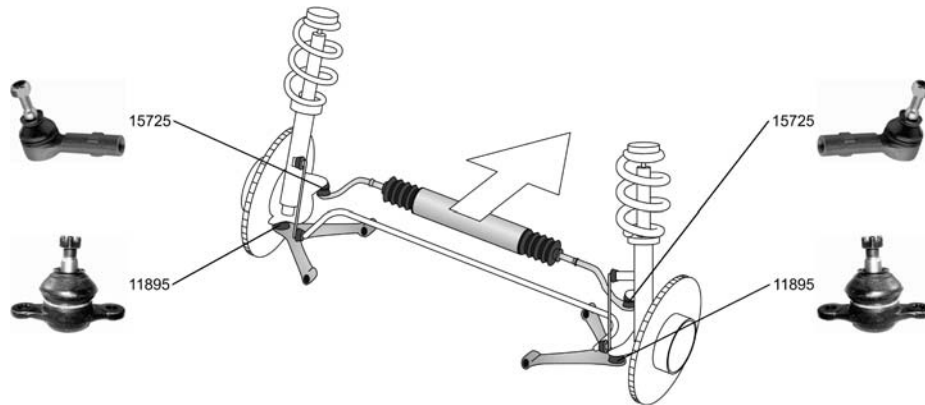

OE

TOYOTA

MR 2 (_W1_)

11.84 - 06.90





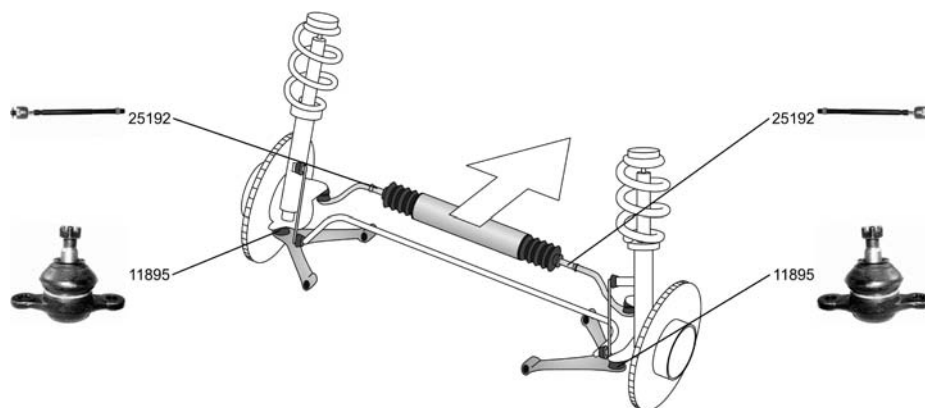

<p>Spurstangenkopf / Tie-rod End Gewindeart: mit Rechtsgewinde / Thread Type: with right-hand thread Gewindemaß / Thread Size:M12x1,25</p>		<p>15725 45046-29135</p> 
<p>ALL TYPES</p>		
<p>Trag-/Führungsgelenk / Support-/ Steering Link Konusmaß [mm] / Cone Size [mm]:14,3</p>		<p>11895 43330-19025</p> 
<p>ALL TYPES</p>		
<p>Faltenbalgsatz, Lenkung / Bellow Kit, steering system</p>		<p>30157 45535-12011</p> 
<p>ALL TYPES</p>	<p>->03.1988</p>	

MR 2 (_W2_)

12.89 - 05.00





<p>Axialgelenk, Spurstange / Axial Rod, tie rod</p>		<p>25192 45503-19145</p> 
<p>2.0 16V (SW20) 12.89 - 05.00 2.0 16V 12.89 - 05.00</p>		
<p>Trag-/Führungsgelenk / Support-/ Steering Link Konusmaß [mm] / Cone Size [mm]:14,3</p>		<p>11895 43330-19025</p> 
<p>2.0 16V (SW20) 12.89 - 05.00 2.0 16V 12.89 - 05.00</p>		



OE





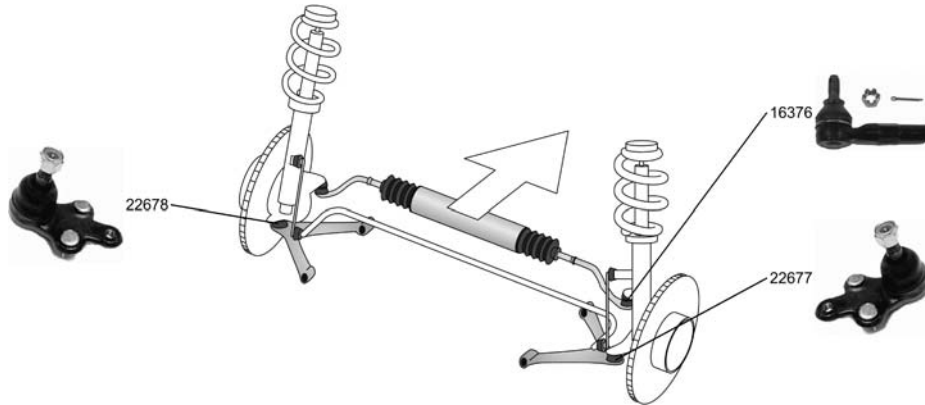

TOYOTA

MR 2 (_W3_) 04.00 -

	Spurstangenkopf / Tie-rod End ALL TYPES		16376 45046-19216
			

PASEO (EL54) 08.95 - 07.99



Spurstangenkopf / Tie-rod End ALL TYPES		16376 45046-19216
		
Trag-/Führungsgelenk / Support-/ Steering Link ALL TYPES	 KBA-Nummer / KBA Number (Germany):5013319 KBA-Nummer / KBA Number (Germany):5013357	22677 43330-19085
		
Trag-/Führungsgelenk / Support-/ Steering Link ALL TYPES	 KBA-Nummer / KBA Number (Germany):5013319 KBA-Nummer / KBA Number (Germany):5013357	22678 43340-19025
		







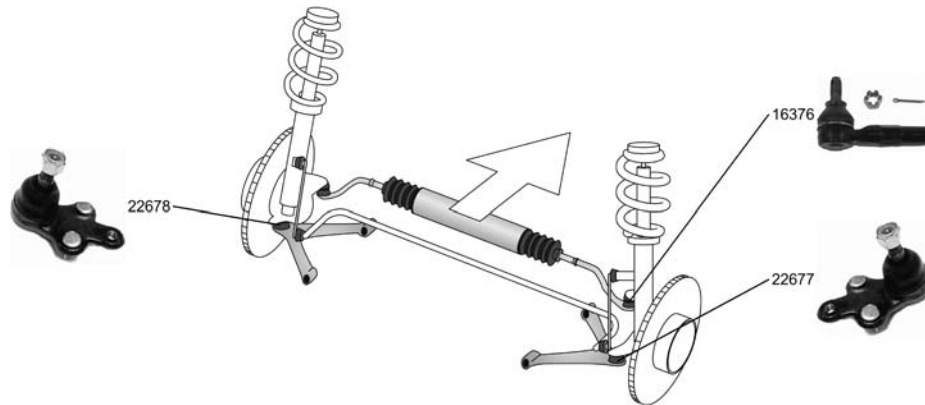

OE

TOYOTA

PASEO Cabrio/Convertible (EL54)

10.96 - 03.99





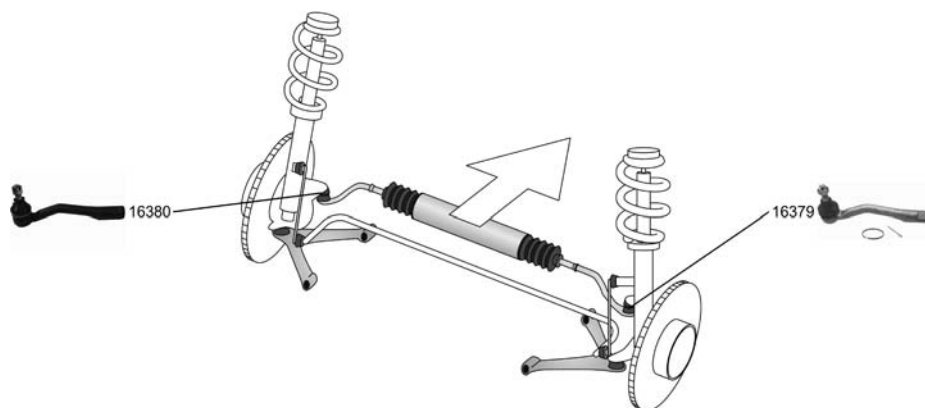

Spurstangenkopf / Tie-rod End ALL TYPES		16376 45046-19216
		
Trag-/Führungsgelenk / Support-/ Steering Link ALL TYPES		22677 43330-19085
	KBA-Nummer / KBA Number (Germany):5013319 KBA-Nummer / KBA Number (Germany):5013357	
Trag-/Führungsgelenk / Support-/ Steering Link ALL TYPES		22678 43340-19025
	KBA-Nummer / KBA Number (Germany):5013319 KBA-Nummer / KBA Number (Germany):5013357	

PICNIC (_XM10)

05.96 -



Spurstangenkopf / Tie-rod End Innengewinde [mm] / Inner Thread [mm]:M15x1,5 Gewindeart: mit Rechtsgewinde / Thread Type: with right-hand thread		16379 45046-29335
2.0 16V (SXM10_) 05.96 - 2.2 D (CMX10_) 08.97 -		
Spurstangenkopf / Tie-rod End Innengewinde [mm] / Inner Thread [mm]:M15x1,5 Gewindeart: mit Rechtsgewinde / Thread Type: with right-hand thread		16380 45047-29075
2.0 16V (SXM10_) 05.96 - 2.2 D (CMX10_) 08.97 -		





TOYOTA

PREVIA (TCR1_, 2_)

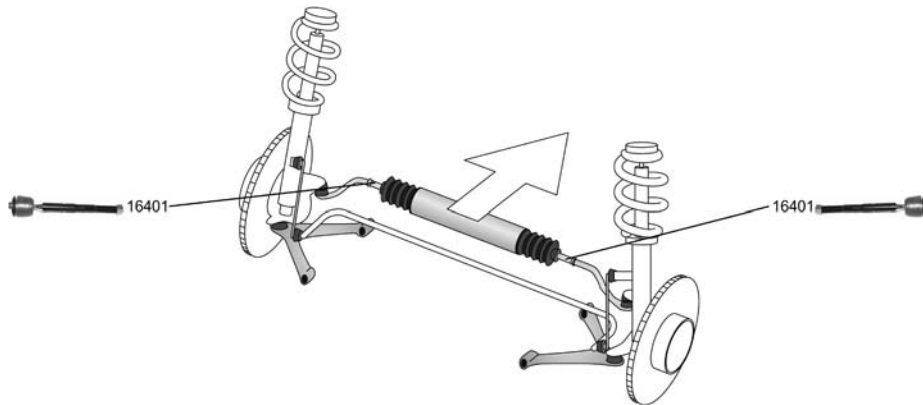
05.90 - 08.00





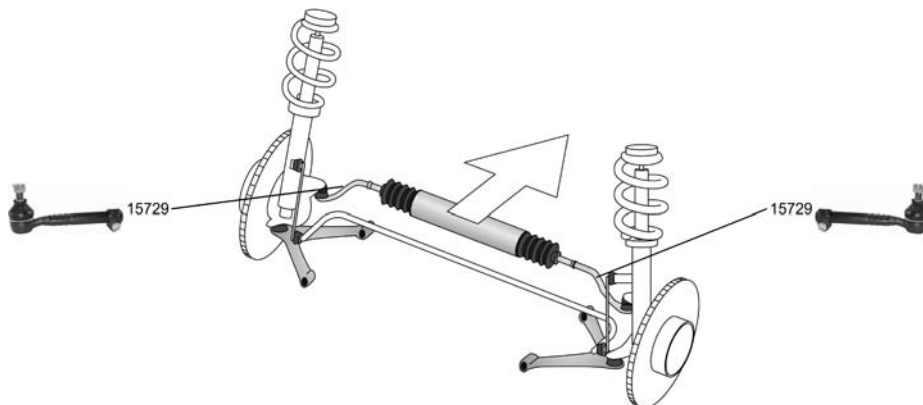

Axialgelenk, Spurstange / Axial Rod, tie rod ALL TYPES		16401 45503-29295
		

RAV 4 I (SXA1_)

06.94 - 06.00



Spurstange / Tie Rod, steering ALL TYPES	 	15729 45460-29225
		
Faltenbalgsatz, Lenkung / Bellow Kit, steering system ALL TYPES		30230 45535-12100
		







OE

TOYOTA

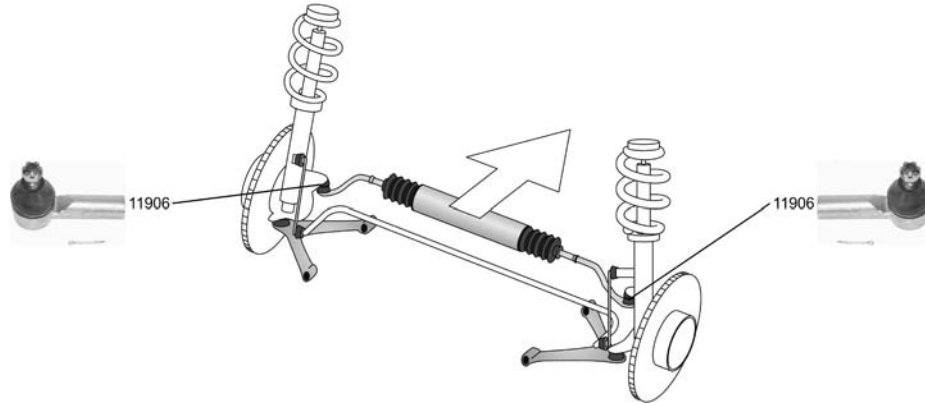
**RAV 4 I Cabrio/open off-road
vehicle/carrosserie ouverte (SXA1_)**

12.97 - 06.00





<p>Spurstangenkopf / Tie-rod End Gewindeart: mit Rechtsgewinde / Thread Type: with right-hand thread Gewindemaß / Thread Size:M14x1,5 Innengewinde [mm] / Inner Thread [mm]:M14x1,5 ALL TYPES</p>		<p>11906 45046-29305</p> 
<p>Faltenbalgsatz, Lenkung / Bellow Kit, steering system ALL TYPES</p>		<p>30230 45535-12100</p> 

RAV 4 II (XA2)

06.00 -









<p>Faltenbalgsatz, Lenkung / Bellow Kit, steering system ALL TYPES</p>		<p>30230 45535-12100</p> 
--	---	--

STARLET (_P7_)

10.84 - 12.89



<p>Spurstangenkopf / Tie-rod End Gewindeart: mit Rechtsgewinde / Thread Type: with right-hand thread Gewindemaß / Thread Size:M12x1,25 Innengewinde [mm] / Inner Thread [mm]:M12x1,25 ALL TYPES</p>		<p>16375 45046-19165</p> 
<p>Axialgelenk, Spurstange / Axial Rod, tie rod Gewindeart: mit Rechtsgewinde / Thread Type: with right-hand thread Gewindemaß / Thread Size:M12x1,25 ALL TYPES</p>		<p>15736 45503-19075</p> 
<p>Trag-/Führungsgelenk / Support-/ Steering Link Konusmaß [mm] / Cone Size [mm]:14,1 ALL TYPES</p>		<p>16430 43330-19075</p> 









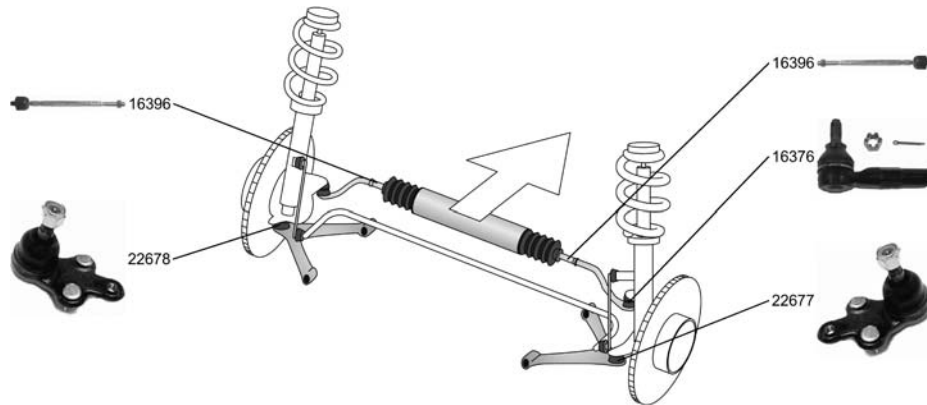

TOYOTA

STARLET (_P8_)

12.89 - 03.96





Spurstangenkopf / Tie-rod End ALL TYPES		16376 45046-19216
		
Axialgelenk, Spurstange / Axial Rod, tie rod		16396 45503-19195
1.3 12V (EP81) KAT 12.89 - 03.96 1.5 D (NP80_) 12.89 - 03.96		
Trag-/Führungsgelenk / Support-/ Steering Link		22677 43330-19085
ALL TYPES		
Trag-/Führungsgelenk / Support-/ Steering Link		22678 43340-19025
ALL TYPES		

STARLET (EP91)

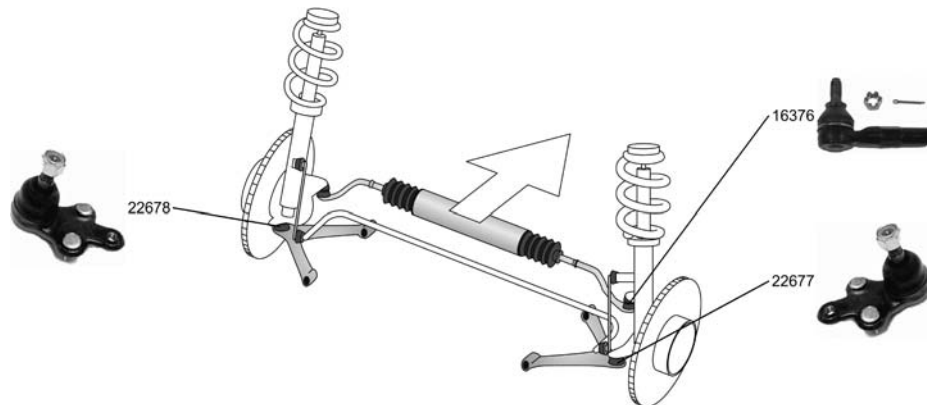
04.96 - 03.99







Spurstangenkopf / Tie-rod End ALL TYPES		16376 45046-19216
		











OE

TOYOTA







STARLET (EP91) 04.96 - 03.99

 Trag-/Führungsgelenk / Support-/ Steering Link ALL TYPES		22677 43330-19085 
Trag-/Führungsgelenk / Support-/ Steering Link ALL TYPES		22678 43340-19025 

TERCEL (AL2_) 10.82 - 01.88

 Spurstangenkopf / Tie-rod End Innengewinde [mm] / Inner Thread [mm]:M14x1,5 Gewindeart: mit Linksgewinde / Thread Type: With left-hand thread		15731 
	1.5 4WD (AL25) 05.86 - 01.88 1.5 4WD 10.82 - 01.88	
Axialgelenk, Spurstange / Axial Rod, tie rod Gewindeart: mit Rechtsgewinde / Thread Type: with right-hand thread Gewindemaß / Thread Size:M14x1,5		15733 45503-19025 
	1.5 4WD (AL25) 05.86 - 01.88 1.5 4WD 10.82 - 01.88	
Trag-/Führungsgelenk / Support-/ Steering Link Konusmaß [mm] / Cone Size [mm]:14,3		11895 43330-19025 
	1.5 4WD (AL25) 05.86 - 01.88 1.5 4WD 10.82 - 01.88	
Faltenbalgsatz, Lenkung / Bellow Kit, steering system		30157 45535-12011 
	1.5 4WD (AL25) 05.86 - 01.88 1.5 4WD 10.82 - 01.88	

TERCEL (_L1_, _L2_) 03.79 - 01.88

 Spurstangenkopf / Tie-rod End Innengewinde [mm] / Inner Thread [mm]:M14x1,5 Gewindeart: mit Linksgewinde / Thread Type: With left-hand thread		15731 
	1.3 (AL20, AL11) 03.79 - 01.88	
Axialgelenk, Spurstange / Axial Rod, tie rod Gewindeart: mit Rechtsgewinde / Thread Type: with right-hand thread Gewindemaß / Thread Size:M14x1,5		15733 45503-19025 
	1.3 (AL20, AL11) 03.79 - 01.88	
Trag-/Führungsgelenk / Support-/ Steering Link Konusmaß [mm] / Cone Size [mm]:14,3		11895 43330-19025 
	1.3 (AL20, AL11) 03.79 - 01.88	





OE

TOYOTA

TERCEL (_L1_, _L2_)







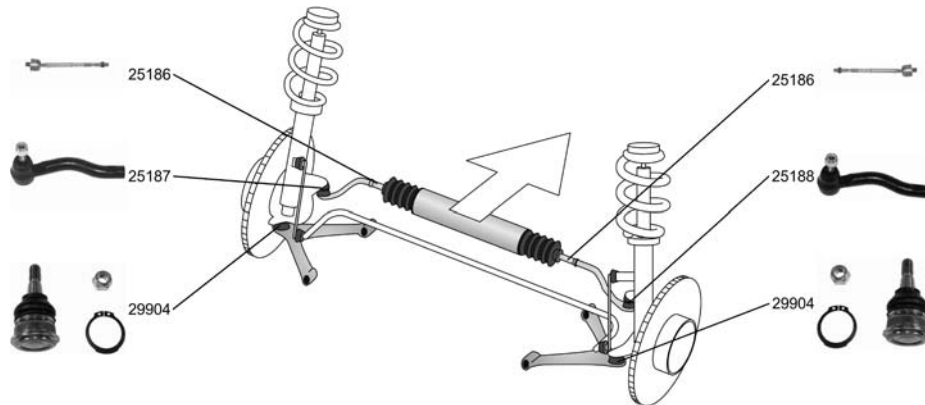

03.79 - 01.88

 Faltenbalgsatz, Lenkung / Bellow Kit, steering system 1.3 (AL20, AL11)	 03.79 - 01.88	30157 45535-12011
		

YARIS (_CP10)

04.99 -



Spurstangenkopf / Tie-rod End ALL TYPES		25187 45047-59026 
Spurstangenkopf / Tie-rod End ALL TYPES		25188 45046-59026 
Axialgelenk, Spurstange / Axial Rod, tie rod 1.0 16V (SCP10_) 1.3 16V (NCP10_)		25186 45503-52010 
Trag-/Führungsgelenk / Support-/ Steering Link ALL TYPES		29904 48068-59035 48069-59035 





OE

TOYOTA



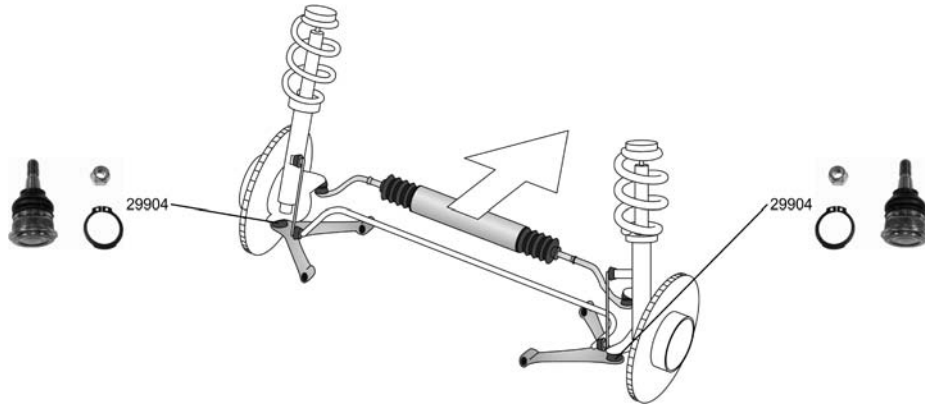





























YARIS VERSO (NC/LP2_)

11.99 -



<p>Trag-/Führungsgelenk / Support-/ Steering Link</p>	<p></p>	<p>29904 48068-59035 48069-59035</p>
<p>ALL TYPES</p>		

Arithmetische Liste / Part number list

Artikelnummer Article No.	Seite Page	Hersteller Manufacturer	Artikelnummer Article No.	Seite Page	Hersteller Manufacturer
11894 	23	TOYOTA	11915 	26 27 28 29	TOYOTA
Trag-/Führungsgelenk / Support-/ Steering Link			Axialgelenk, Spurstange / Axial Rod, tie rod		
11895 	51 57	TOYOTA	11916 	10 11 12	TOYOTA
Trag-/Führungsgelenk / Support-/ Steering Link			Axialgelenk, Spurstange / Axial Rod, tie rod		
11896 	40 41 42	TOYOTA	11917 	41 42 43	TOYOTA
Trag-/Führungsgelenk / Support-/ Steering Link			Axialgelenk, Spurstange / Axial Rod, tie rod		
11897 	9 10 23 24 25 26	TOYOTA	11918 	30 31 32 33 34 35 36 37 38	TOYOTA
Trag-/Führungsgelenk / Support-/ Steering Link			Axialgelenk, Spurstange / Axial Rod, tie rod		
11898 	48 49 50	TOYOTA	11919 	14 15 17	TOYOTA
Trag-/Führungsgelenk / Support-/ Steering Link			Axialgelenk, Spurstange / Axial Rod, tie rod		
11900 	5 6 7	TOYOTA	11920 	14 15 17	TOYOTA
Trag-/Führungsgelenk / Support-/ Steering Link			Axialgelenk, Spurstange / Axial Rod, tie rod		
11901 	26 27 28 29	TOYOTA	11921 	26 27 28 29	TOYOTA
Trag-/Führungsgelenk / Support-/ Steering Link			Stange/Strebe, Stabilisator / Rod/Strut, stabiliser		
11902 	44	TOYOTA	11922 	30 31 32 33 34 35 36 37 38	TOYOTA
Trag-/Führungsgelenk / Support-/ Steering Link			Stange/Strebe, Stabilisator / Rod/Strut, stabiliser		
11903 	41 42	TOYOTA	14943 	11 12 13	TOYOTA
Trag-/Führungsgelenk / Support-/ Steering Link			Stange/Strebe, Stabilisator / Rod/Strut, stabiliser		
11904 	48 49 50	TOYOTA	14945 	6 7 11 12 13 31 32 33 34 35 36 37 38	TOYOTA
Trag-/Führungsgelenk / Support-/ Steering Link			Stange/Strebe, Stabilisator / Rod/Strut, stabiliser		
11905 	40 41	TOYOTA	15191 	48	TOYOTA
Trag-/Führungsgelenk / Support-/ Steering Link			Trag-/Führungsgelenk / Support-/ Steering Link		
11906 	6 7 8 9 18 19 20 21 22 24 25 26 27 28 29 30 31 32 33 34 35 36 37 38 55	TOYOTA	15195 	17 18 48 49	TOYOTA
Spurstangenkopf / Tie-rod End			Axialgelenk, Spurstange / Axial Rod, tie rod		
11907 	1 40 41 43	TOYOTA	15713 	18	TOYOTA
Spurstangenkopf / Tie-rod End			Trag-/Führungsgelenk / Support-/ Steering Link		
11908 	43	TOYOTA	15714 	26 27 28 29	TOYOTA
Spurstangenkopf / Tie-rod End			Trag-/Führungsgelenk / Support-/ Steering Link		
11913 	23	TOYOTA	15715 	2 4 21 22 23	TOYOTA
Axialgelenk, Spurstange / Axial Rod, tie rod			Trag-/Führungsgelenk / Support-/ Steering Link		
11914 	9 23 24 25	TOYOTA	15717 	1 44	TOYOTA
Axialgelenk, Spurstange / Axial Rod, tie rod			Trag-/Führungsgelenk / Support-/ Steering Link		
			15719 	47 50	TOYOTA
			Spurstangenkopf / Tie-rod End		

Artikelnummer Article No.	Seite Page	Hersteller Manufacturer	Artikelnummer Article No.	Seite Page	Hersteller Manufacturer
15722	10 11 12	TOYOTA	16378	10 11 12	TOYOTA
Spurstangenkopf / Tie-rod End			Spurstangenkopf / Tie-rod End		
15725	8 9 24	TOYOTA	16379	13 15 16	TOYOTA
Spurstangenkopf / Tie-rod End	51		Spurstangenkopf / Tie-rod End	53	
15729	17 22 54	TOYOTA	16380	13 15 16	TOYOTA
Spurstange / Tie Rod, steering			Spurstangenkopf / Tie-rod End	53	
15731	57	TOYOTA	16388	5 7 8	TOYOTA
Spurstangenkopf / Tie-rod End			Spurstangenkopf / Tie-rod End		
15733	26 57	TOYOTA	16390	9 10	TOYOTA
Axialgelenk, Spurstange / Axial Rod, tie rod			Axialgelenk, Spurstange / Axial Rod, tie rod		
15734	9 24 25	TOYOTA	16394	26 27 28	TOYOTA
Axialgelenk, Spurstange / Axial Rod, tie rod			Axialgelenk, Spurstange / Axial Rod, tie rod	29	
15736	55	TOYOTA	16395	11 12 13	TOYOTA
Axialgelenk, Spurstange / Axial Rod, tie rod			Axialgelenk, Spurstange / Axial Rod, tie rod		
15737	5	TOYOTA	16396	56	TOYOTA
Axialgelenk, Spurstange / Axial Rod, tie rod			Axialgelenk, Spurstange / Axial Rod, tie rod		
15738	18 20	TOYOTA	16397	48 49 50	TOYOTA
Axialgelenk, Spurstange / Axial Rod, tie rod			Axialgelenk, Spurstange / Axial Rod, tie rod		
15740	48 49 50	TOYOTA	16398	20 21	TOYOTA
Axialgelenk, Spurstange / Axial Rod, tie rod			Axialgelenk, Spurstange / Axial Rod, tie rod		
15741	30 31 32	TOYOTA	16400	6 8	TOYOTA
Axialgelenk, Spurstange / Axial Rod, tie rod	33		Axialgelenk, Spurstange / Axial Rod, tie rod		
16352	43 44 50	TOYOTA	16401	54	TOYOTA
Spurstangenkopf / Tie-rod End			Axialgelenk, Spurstange / Axial Rod, tie rod		
16353	40 44 50	TOYOTA	16408	23 25	TOYOTA
Spurstangenkopf / Tie-rod End			Spurstangenkopf / Tie-rod End		
16361	40 41	TOYOTA	16426	44	TOYOTA
Spurstangenkopf / Tie-rod End			Trag-/Führungsgelenk / Support-/ Steering Link		
16371	44 45	TOYOTA	16428	6	TOYOTA
Spurstangenkopf / Tie-rod End			Trag-/Führungsgelenk / Support-/ Steering Link		
16372	44 45	TOYOTA	16429	9 10 11	TOYOTA
Spurstangenkopf / Tie-rod End			Trag-/Führungsgelenk / Support-/ Steering Link	12 13 18	
16373	44 45	TOYOTA	16430	55	TOYOTA
Spurstangenkopf / Tie-rod End			Trag-/Führungsgelenk / Support-/ Steering Link		
16374	48 49 50	TOYOTA	16431	1 44	TOYOTA
Spurstangenkopf / Tie-rod End			Trag-/Führungsgelenk / Support-/ Steering Link		
16375	55	TOYOTA			
Spurstangenkopf / Tie-rod End					
16376	52 53 56	TOYOTA			
Spurstangenkopf / Tie-rod End					

Arithmetische Liste / Part number list

Artikelnummer Article No.	Seite Page	Hersteller Manufacturer	Artikelnummer Article No.	Seite Page	Hersteller Manufacturer
16432	2 3 4	TOYOTA	29904	58 59	TOYOTA
Trag-/Führungsgelenk / Support-/ Steering Link	14 15 17 30 31 33		Trag-/Führungsgelenk / Support-/ Steering Link		
16439	2 3 4	TOYOTA	30157	24 25 27	TOYOTA
Stange/Strebe, Stabilisator / Rod/Strut, stabiliser	14 15 17		Faltenbalgsatz, Lenkung / Bellow Kit, steering system	28 30 51 57 58	
16440	2 3 4	TOYOTA	30226	30 31 32	TOYOTA
Stange/Strebe, Stabilisator / Rod/Strut, stabiliser	14 16 17		Faltenbalgsatz, Lenkung / Bellow Kit, steering system	33	
16819	45 46 47	TOYOTA	30227	14 16 17	TOYOTA
Spurstangenkopf / Tie-rod End			Faltenbalgsatz, Lenkung / Bellow Kit, steering system		
16847	47	TOYOTA	30230	14 16 17	TOYOTA
Spurstangenkopf / Tie-rod End			Faltenbalgsatz, Lenkung / Bellow Kit, steering system	30 31 32 33 34 35 36 37 54 55	
16862	46 47	TOYOTA	30236	46 47	TOYOTA
Spurstangenkopf / Tie-rod End			Faltenbalgsatz, Lenkung / Bellow Kit, steering system		
22677	52 53 56	TOYOTA	30240	14 16 17	TOYOTA
Trag-/Führungsgelenk / Support-/ Steering Link	57		Faltenbalgsatz, Lenkung / Bellow Kit, steering system		
22678	52 53 56	TOYOTA			
Trag-/Führungsgelenk / Support-/ Steering Link	57				
22680	45	TOYOTA			
Spurstangenkopf / Tie-rod End					
22681	46	TOYOTA			
Spurstangenkopf / Tie-rod End					
22682	45	TOYOTA			
Spurstangenkopf / Tie-rod End					
24729	1 2 3	TOYOTA			
Spurstangenkopf / Tie-rod End	13 15 16				
24730	1 2 3	TOYOTA			
Spurstangenkopf / Tie-rod End	14 15 16				
25186	58	TOYOTA			
Axialgelenk, Spurstange / Axial Rod, tie rod					
25187	58	TOYOTA			
Spurstangenkopf / Tie-rod End					
25188	58	TOYOTA			
Spurstangenkopf / Tie-rod End					
25192	51	TOYOTA			
Axialgelenk, Spurstange / Axial Rod, tie rod					
25198	2 3	TOYOTA			
Axialgelenk, Spurstange / Axial Rod, tie rod					
26601	6 8	TOYOTA			
Lagerung, Lenker / Mounting, wishbone					
29797	4 5 34	TOYOTA			
Stange/Strebe, Stabilisator / Rod/Strut, stabiliser	36 38 39 40				

Vergleichsliste / Cross reference list

Vergleichs-Nr. Compare No.	Artikelnummer Article No.
-------------------------------	------------------------------

TOYOTA

43308-19035	11894
43308-29115	15713
43330-19025	11895
43330-19066	15714
43330-19075	16430
43330-19085	22677
43330-29095	15191
43330-29155	11896
43330-29185	16429
43330-29205	11897
43330-29245	11898
43330-29326	15715
43330-29375	16432
43330-39265	16431
43330-39275	11900
43330-39295	11902
43340-19016	11901
43340-19025	22678
43350-29036	11904
43350-29056	11905
43350-29065	11903
43350-39115	16426
43360-39085	15717
45044-69055	22680
45044-69085	22681
45044-69125	16847
45045-69045	22682
45045-69065	16819
45046-19165	16375
45046-19216	16376
45046-29135	15725
45046-29155	15719
45046-29165	16378
45046-29186	16374
45046-29255	16388
45046-29305	11906
45046-29335	16379
45046-29365	24730
45046-39095	16352
45046-39235	11907
45046-59026	25188
45046-69055	16371
45046-69115	16373
45047-29045	15722
45047-29075	16380
45047-29125	24729
45047-39065	16353
45047-59026	25187
45047-69065	16372
45047-69085	16862
45406-29145	16361
45406-39155	11908
45460-19215	16408
45460-29225	15729
45503-05010	11919
45503-05020	25198
45503-19025	15733
45503-19035	15734
45503-19036	11914
45503-19045	11913
45503-19056	16390

Vergleichs-Nr. Compare No.	Artikelnummer Article No.
-------------------------------	------------------------------

TOYOTA

45503-19075	15736
45503-19125	11915
45503-19135	16394
45503-19145	25192
45503-19195	16396
45503-29075	15738
45503-29125	15195
45503-29135	15740
45503-29155	11916
45503-29165	16395
45503-29215	16397
45503-29245	16398
45503-29255	11917
45503-29295	16401
45503-29365	15741
45503-29385	11918
45503-29475	11920
45503-39015	15737
45503-39135	16400
45503-52010	25186
45535-05010	30227
45535-12011	30157
45535-12060	30226
45535-12100	30230
45535-20080	30240
45535-60010	30236
48068-59035	29904
48069-59035	29904
48655-33040	26601
48810-05012	16440
48810-20010	14943
48820-05012	16439
48820-20010	11921
48820-33010	11922
48820-47010	29797
48830-20010	14945

Vergleichs-Nr. Compare No.	Artikelnummer Article No.
-------------------------------	------------------------------

Neuaufnahmen / New to range

Artikelnummer Article No.	Seite Page	Hersteller Manufacturer
11894	23	TOYOTA
11900	5 6 7	TOYOTA
11901	26 27 28	TOYOTA
	29	
11913	23	TOYOTA
11914	9 23 24	TOYOTA
	25	
11917	41 42 43	TOYOTA
11919	14 15 17	TOYOTA
11921	26 27 28	TOYOTA
	29	
11922	30 31 32	TOYOTA
	33 34 35	
	36 37 38	
14945	6 7 11	TOYOTA
	12 13 31	
	32 33 34	
	35 36 37	
	38	
15191	48	TOYOTA
15195	17 18 48	TOYOTA
	49	
15713	18	TOYOTA
15715	2 4 21	TOYOTA
	22 23	
15719	47 50	TOYOTA
15725	8 9 24	TOYOTA
	51	
15729	17 22 54	TOYOTA
15733	26 57	TOYOTA
15737	5	TOYOTA
15740	48 49 50	TOYOTA
16361	40 41	TOYOTA
16373	44 45	TOYOTA
16374	48 49 50	TOYOTA
16376	52 53 56	TOYOTA
16380	13 15 16	TOYOTA
	53	
16388	5 7 8	TOYOTA
16390	9 10	TOYOTA
16394	26 27 28	TOYOTA
	29	
16395	11 12 13	TOYOTA
16397	48 49 50	TOYOTA
16400	6 8	TOYOTA
16401	54	TOYOTA
16408	23 25	TOYOTA
16426	44	TOYOTA
16431	1 44	TOYOTA
16439	2 3 4	TOYOTA
	14 15 17	
16440	2 3 4	TOYOTA
	14 16 17	
16819	45 46 47	TOYOTA
16862	46 47	TOYOTA
22677	52 53 56	TOYOTA
	57	
22678	52 53 56	TOYOTA
	57	
22680	45	TOYOTA
22681	46	TOYOTA
22682	45	TOYOTA

Artikelnummer Article No.	Seite Page	Hersteller Manufacturer
24729	1 2 3	TOYOTA
	13 15 16	
24730	1 2 3	TOYOTA
	14 15 16	
25186	58	TOYOTA
25187	58	TOYOTA
25188	58	TOYOTA
25192	51	TOYOTA
25198	2 3	TOYOTA
29797	4 5 34	TOYOTA
	36 38 39	
	40	
29904	58 59	TOYOTA
30157	24 25 27	TOYOTA
	28 30 51	
	57 58	
30226	30 31 32	TOYOTA
	33	
30227	14 16 17	TOYOTA
30230	14 16 17	TOYOTA
	30 31 32	
	33 34 35	
	36 37 54	
	55	
30236	46 47	TOYOTA
30240	14 16 17	TOYOTA

Geänderte Bestellnummer / Amended part numbers

Artikelnummer alt Article No. old	Artikelnummer neu Article No. new	Artikelnummer alt Article No. old	Artikelnummer neu Article No. new	Artikelnummer alt Article No. old	Artikelnummer neu Article No. new
15339	14945				
15742	30157				

Geänderte Bestellnummer / Amended part numbers

Artikelnummer neu Article No. new	Artikelnummer alt Article No. old	Artikelnummer neu Article No. new	Artikelnummer alt Article No. old	Artikelnummer neu Article No. new	Artikelnummer alt Article No. old
14945	15339				
30157	15742				

© ZF Trading GmbH - 14.10.06